



HVAC

PRODUCT APPLICATIONS & SELECTION GUIDES

Pressure | Temperature | Test & Data | Air Quality
Flow | Level | Process Control | Valves





The **trusted leader** in manufacturing innovative instrumentation solutions for the **worldwide** HVAC and process automation markets

CUSTOMER SATISFACTION

Meet and exceed customer and market expectations

INNOVATIVE

Sustained R&D and product development

COMPETITIVE

Highly automated and flexible manufacturing capabilities

TRUSTED

High-quality, reliable, and readily available products and solutions

GLOBAL SUPPORT

Global sales and marketing presence

ESTABLISHED DWYER BRANDS



DWYER AROUND THE GLOBE



CONTACT INFORMATION

CORPORATE HEADQUARTERS

DWYER INSTRUMENTS, INC.
102 Indiana Highway 212
P.O. Box 373
Michigan City, IN 46360, U.S.A.

DWYER-INST.COM

Phone | (219) 879-8000
Toll-Free | (800) 872-9141
Fax | (219) 872-9057

UNITED KINGDOM

DWYER INSTRUMENTS LTD
Unit 16, The Wye Estate, London Road
High Wycombe, Bucks HP11 1LH-U.K.

DWYER-INST.CO.UK

Phone | +44 (0) 1494 461707
Fax | +44 (0) 1494 465102

AUSTRALIA

DWYER INSTRUMENTS, PTY. LTD.
Unit 1, 11 Waverley Drive
P.O. Box 359
Unanderra, NSW 2526 Australia

DWYER-INST.COM.AU

Phone | +61 (0) 2 4272 2055
Fax | +61 (0) 2 4272 4055

HONG KONG

DWYER INSTRUMENTS HK, LTD.
Unit 605A, 6/F, Shui Hing Centre
13 Sheung Yuet Road,
Kowloon Bay, Hong Kong

DWYER-INST.COM.HK

Phone | +852-23181007
Fax | +852-27561565

OTHER CONTACTS

ORDERS

orders@dwyermail.com

TECHNICAL SUPPORT

tech@dwyermail.com

LITERATURE REQUESTS

lit@dwyermail.com

QUOTATION/BID REQUESTS

quotes@dwyermail.com

GENERAL INFORMATION

info@dwyermail.com

INTERNATIONAL CUSTOMERS

Dwyer has local distributors in over 79 countries. Contact the office of your country or contact the corporate headquarters to find your local distributor. You can also go to our website at the following address to be contacted by your local distributor: dwyer-inst.com/Distributor

ABOUT US

Since the company was founded in 1931, customers have come to recognize Dwyer Instruments, Inc. to stand for quality, reliability, and readily available competitively priced products. As a leading manufacturer in the controls and instrumentation industry, we continue to grow and serve major markets including, but not limited to: HVAC, chemical, agriculture, food, oil and gas, water, wastewater, powder and bulk, and pollution control.

Dwyer holds over 650 technical patents and that number grows every year. We are an enthusiastic group of people headquartered in Michigan City, Indiana, with satellite locations around the globe. We take great pride in the intellect and integrity of our employees, who are passionate about the work we do, the products we develop, and the industries we serve.

MANUFACTURING EXCELLENCE

At Dwyer, it all starts with commitment to meeting the needs of our customers. We strive to make dependable, easy-to-use products.

With nearly 90 years of manufacturing expertise, we stand behind our high quality products. Dwyer products are trusted in applications all over the world in nearly every industry.



MANUFACTURING & DESIGN CENTER LOCATIONS

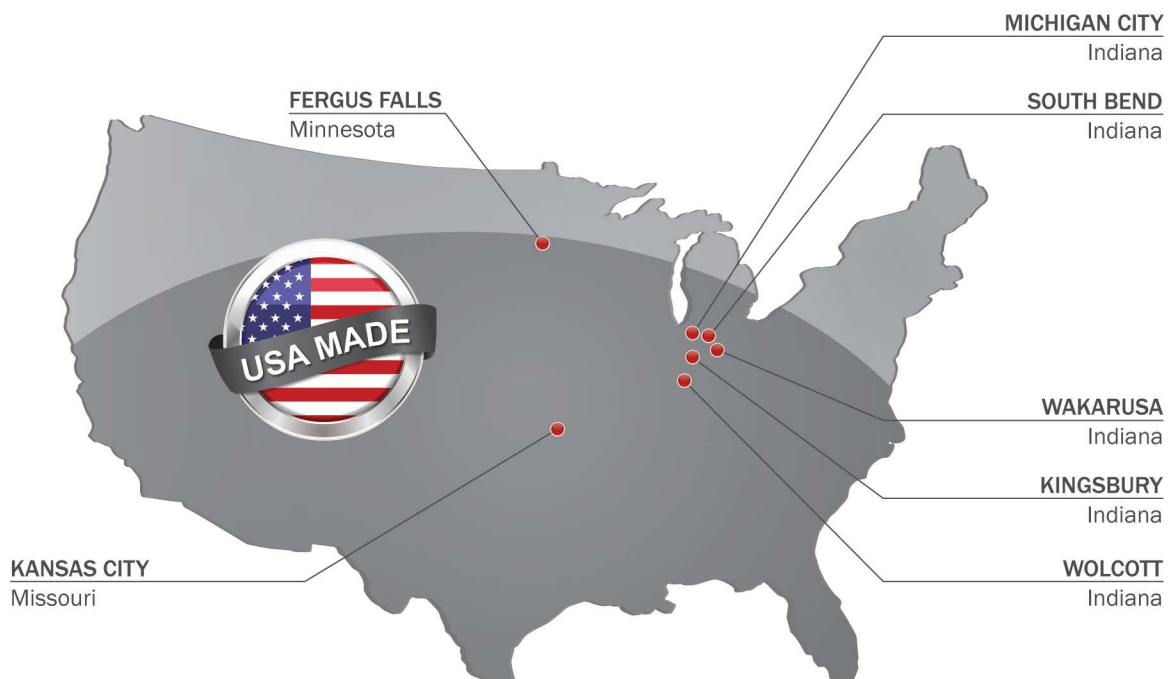

OUR PEOPLE MAKE THE DIFFERENCE

CUSTOMER SERVICE

CUSTOMER CARE

Courteous and professional customer service representatives are available via phone and email to process and provide assistance with your order. Dwyer provides industry leading response time to answer your call quickly without waiting.

PRICING

Contact us for formal quotes. Dwyer offers bids and project quotes. Discounts are available for particular customer types based on quantities purchased.

PRODUCT DELIVERY

LARGE INVENTORY LOCATED CENTRALLY IN THE U.S.A.

Dwyer is committed to process and ship your order as quickly as possible, with more than 5,000 items stocked in our South Bend, Indiana warehouse. In most cases lead time is less than one week for non-stocked products.

FAST PROCESSING & PACKING

Our dedicated shipping staff packs and ships your order same day on stocked items ordered before 1:00 PM U.S. Eastern Time.

FLEXIBLE SHIPPING

Dwyer offers blanket orders for OEMs to schedule out your product shipments for when you need them. Contact us for details.

TECHNICAL SUPPORT

All of our technical sales staff members are degreed engineers trained to be product and industry experts. We listen to your needs and get you the answers you want quickly.

WE HELP YOU FIND A SOLUTION

- Product Selection
- Application Assistance
- Regulatory and Agency Approval Compliance
- Installation Guidance
- Maintenance and Repair
- Product Customization for OEMs

TO CONTACT AN APPLICATIONS ENGINEER

PHONE: (219) 879-8000 | FAX: (219) 872-9057 | EMAIL: tech@dwyermail.com

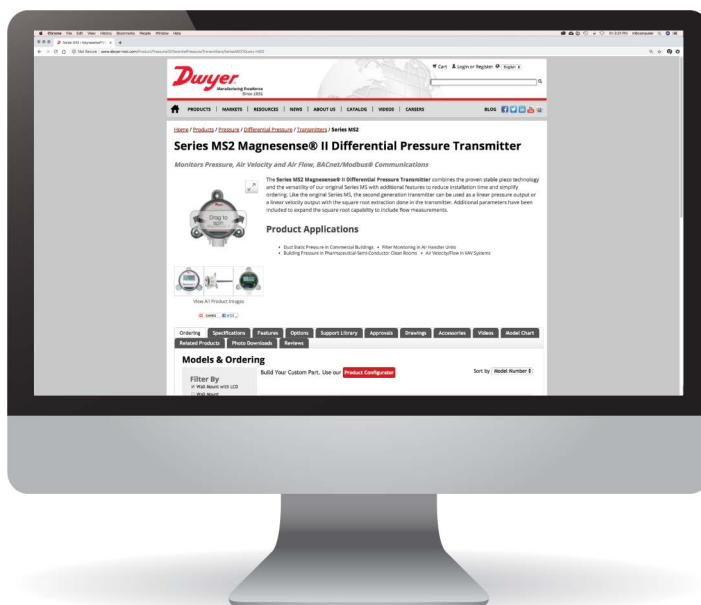

DWYER ONLINE

WEBSITE FEATURES

- Product Search
- Free Literature – Catalogs, Brochures, and Product Selection Guides
- Product Application and Technical Guides
- Digital Catalogs
- Dedicated Support Product Pages
- Video Library

PRODUCT PAGE FEATURES

- Easy Online Ordering
- Product Support Library – Instruction Manuals, Catalog Pages, and Data Sheets
- Product Configurator – Customize a Dwyer product to your specific application needs
- Agency Approval Certificates – CE, IECEx, FM, UL, CSA and ATEX
- Instructional and Informational Videos
- Product Drawings and Photography

DWYER CATALOG APP

Browse the Dwyer catalog online or download it for instant access offline. The Dwyer Catalog App is available in the iTunes® and Google Play™ stores.



CONNECT WITH US

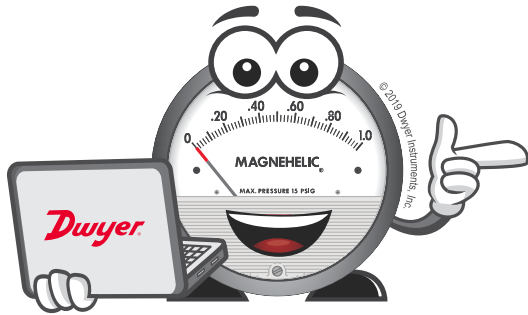

WWW.DWYER-INST.COM/SOCIAL

Dwyer Instruments, Inc. is active on multiple social media platforms so you can stay connected with us throughout the year. Follow us on Facebook, LinkedIn, and Twitter so you're always up to date on new products and services, and learn about our company as a whole.

In addition, the Dwyer blog is updated weekly with articles written by our team of experts. These articles will help to give you a better understanding of the various industries we serve, while allowing you to gain in-depth knowledge of application case studies and helpful tips for Dwyer products.

SPECIAL MODELS FOR OEM REQUIREMENTS

Special instrument designs can be supplied to meet a wide range of OEM requirements and specific application needs. Custom scales and private brand identification can easily be furnished. These include: chrome or specially painted bezels, special membranes, special ranges and calibrations, dual scales, reflective scales, special cleaning and OEM identification. For specific information please contact our customer service department at 219-879-8000.

CUSTOMIZED FOR YOU

OFFERED IN A WIDE VARIETY OF DESIGNS, FEATURES & SCALES



CALIBRATION & REPAIR SERVICES

DEDICATED

Dwyer's dedication to quality is unmatched in the industry. We go above and beyond to provide impeccable service paired with quality calibrations.

COMMITTED

We understand being without your instrument can cost you money. We are committed to getting you your instrument back as fast as possible.

ACCURATE

You can feel confident by sending your equipment back to the original manufacturer.

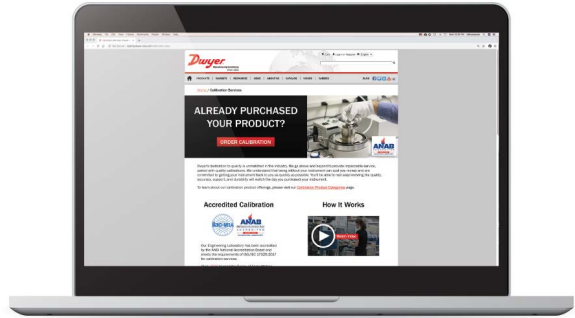

CALIBRATION CAPABILITIES

ELECTRICAL

- Digital Multimeters
- Clamp-on Meters
- Amp Meters
- Volt Meters
- Data Loggers
- Optical Tachometers

PRESSURE

- Magnehelic® Differential Pressure Gage
- Absolute Gages
- Manometers
- Micromanometers
- Differential Pressure Gages

VELOCITY & AIR FLOW

- SMART Air Hood® Balancing Instrument
- Rotating Vane
- Anemometer
- Ultrasonic Flowmeter
- Insertion Flow Transmitter

TEMPERATURE

- Controllers
- Probes
- Transmitters

HUMIDITY

- Probes
- Transmitters



Our Engineering Laboratory has been accredited by the ANSI National Accreditation Board and meets the requirements of ISO/IEC 17025:2017 for calibration services.

See our scope of accreditation for details at <http://www.dwyer-inst.com/calibration/scope>

CALIBRATION & REPAIR SERVICES

— ISO/IEC 17025 ACCREDITED CERTIFICATE OF CALIBRATION

An ISO/IEC 17025 Accredited Certificate of Calibration is available on select products at an additional charge (email accreditedcal@dwyermail.com for additional information). This certificate is created in our ANAB Accredited Standards Laboratory guaranteeing the calibration work performed is in agreement with the internationally recognized standards (i.e. ISO/IEC 17025:2017). Measurement and Test Equipment (M&TE) used in the calibration are traceable to NMI's (such as NIST) and are calibrated regularly at established intervals. The certificate includes all information regarding M&TE, environmental conditions, procedures used, data obtained for the unit under test (UUT), estimated measurement uncertainties (EMU), test uncertainty ratios (TUR) and probability of false acceptance (PFA) (TUR and PFA values are an additional charge). Pricing and availability varies by product. Additional or customer requested test points during the calibration are an additional charge.

Dwyer Calibration CERTIFICATE OF CALIBRATION

3000 Westborough, IL
 60 West Appleton St., Webster, IL, USA 60595
 Telephone: +1 815 724 1111 • Fax: +1 815 724 1112
 Certificate of Accreditation Number: 020225

Customer Information

Customer Name: [REDACTED] Certificate Number: **1507016132**
 Contact Name: [REDACTED] Email: [REDACTED]
 Customer Address: [REDACTED] Street Address: [REDACTED]
 City: [REDACTED] State: [REDACTED] Zip: [REDACTED]
 Country: [REDACTED]

Equipment Information

Equipment Name	Serial Number	Lot Number	UUT Calibration Date	Next Calibration Due	Due Date
...

Calibration Data

Item	Value	Uncertainty	TUR	PFA
...

Page 1 of 1

Dwyer Calibration CERTIFICATE OF CALIBRATION

3000 Westborough, IL
 60 West Appleton St., Webster, IL, USA 60595
 Telephone: +1 815 724 1111 • Fax: +1 815 724 1112
 Certificate of Accreditation Number: 020225

Customer Information

Customer Name: [REDACTED] Certificate Number: [REDACTED]
 Contact Name: [REDACTED] Email: [REDACTED]
 Customer Address: [REDACTED] Street Address: [REDACTED]
 City: [REDACTED] State: [REDACTED] Zip: [REDACTED]
 Country: [REDACTED]

Equipment Information

Item	Value	Uncertainty	TUR	PFA
1.00	0.00	0.01	100	1.00%
1.01	0.01	0.01	100	1.00%
1.02	0.02	0.01	100	1.00%
1.03	0.03	0.01	100	1.00%
1.04	0.04	0.01	100	1.00%
1.05	0.05	0.01	100	1.00%
1.06	0.06	0.01	100	1.00%
1.07	0.07	0.01	100	1.00%
1.08	0.08	0.01	100	1.00%
1.09	0.09	0.01	100	1.00%
1.10	0.10	0.01	100	1.00%
1.11	0.11	0.01	100	1.00%
1.12	0.12	0.01	100	1.00%
1.13	0.13	0.01	100	1.00%
1.14	0.14	0.01	100	1.00%
1.15	0.15	0.01	100	1.00%
1.16	0.16	0.01	100	1.00%
1.17	0.17	0.01	100	1.00%
1.18	0.18	0.01	100	1.00%
1.19	0.19	0.01	100	1.00%
1.20	0.20	0.01	100	1.00%
1.21	0.21	0.01	100	1.00%
1.22	0.22	0.01	100	1.00%
1.23	0.23	0.01	100	1.00%
1.24	0.24	0.01	100	1.00%
1.25	0.25	0.01	100	1.00%
1.26	0.26	0.01	100	1.00%
1.27	0.27	0.01	100	1.00%
1.28	0.28	0.01	100	1.00%
1.29	0.29	0.01	100	1.00%
1.30	0.30	0.01	100	1.00%
1.31	0.31	0.01	100	1.00%
1.32	0.32	0.01	100	1.00%
1.33	0.33	0.01	100	1.00%
1.34	0.34	0.01	100	1.00%
1.35	0.35	0.01	100	1.00%
1.36	0.36	0.01	100	1.00%
1.37	0.37	0.01	100	1.00%
1.38	0.38	0.01	100	1.00%
1.39	0.39	0.01	100	1.00%
1.40	0.40	0.01	100	1.00%
1.41	0.41	0.01	100	1.00%
1.42	0.42	0.01	100	1.00%
1.43	0.43	0.01	100	1.00%
1.44	0.44	0.01	100	1.00%
1.45	0.45	0.01	100	1.00%
1.46	0.46	0.01	100	1.00%
1.47	0.47	0.01	100	1.00%
1.48	0.48	0.01	100	1.00%
1.49	0.49	0.01	100	1.00%
1.50	0.50	0.01	100	1.00%

Calibration Data

Item	Value	Uncertainty	TUR	PFA
...

Page 1 of 1

— CERTIFICATE OF NIST CALIBRATION

A Certificate of NIST Calibration is available for most indicating and transmitting instrumentation products at an additional charge. This certificate is created in our testing lab to NIST traceable test instruments and includes test points with recorded data and the reference standard. Pricing and availability varies by product. Please consult the options listing for the product on the catalog page or see the product on our website for availability.

Dwyer Calibration CERTIFICATE OF CALIBRATION

3000 Westborough, IL
 60 West Appleton St., Webster, IL, USA 60595
 Telephone: +1 815 724 1111 • Fax: +1 815 724 1112
 Certificate of Accreditation Number: 020225

Customer Information

Customer Name: [REDACTED] Certificate Number: [REDACTED]
 Contact Name: [REDACTED] Email: [REDACTED]
 Customer Address: [REDACTED] Street Address: [REDACTED]
 City: [REDACTED] State: [REDACTED] Zip: [REDACTED]
 Country: [REDACTED]

Device Under Test (DUT)

ID Number: [REDACTED]
 Type: Thermal Anemometer
 Description: Air Velocity Measurement Device
 MFR: Dwyer Instruments
 Model: [REDACTED]
 Accuracy: [REDACTED]
 Unit: [REDACTED]
 Output 1: [REDACTED]
 Output 2: [REDACTED]

Address Where Calibration Was Performed

Dwyer Instruments
 102 Highway 312
 Michigan City, IN 46360

Calibration Procedure

Procedure: [REDACTED]
 Reference: [REDACTED]
 Status: As Found As Left
 Test Range: [REDACTED]
 Note: Worst Case calibration uncertainty: $\pm 1.25\%$ reading

Reference Standards Used

Variable	ID#	Last Cal	Due Date
Temp
Hum
Barometric Pressure

As Found/As Left Calibration Data (all values in %)

RESULT	Target Test Point	Calibration Reading	DUT Reading (U)	DUT Reading (C)	Corrected to	Allowable Range
PASSED
PASSED
PASSED
PASSED
PASSED

Page 1 of 1

KEY MARKETS



HVAC

- Building Automation
- Test Equipment
- Critical Environments
(Healthcare, Isolation Rooms, Clean Rooms)
- Original Equipment
(Air Handlers, Boilers, Chillers, Cooling Towers)
- Valve Automation



PROCESS AUTOMATION

- Water and Wastewater
- Pharmaceutical
- Agriculture and Livestock
- Bulk Handling
- Industrial Process
- Mining and Heavy Earth Moving
- Oil, Gas and Petrochemical
- Power
- Valve Automation
- Semiconductor
- Laboratory Equipment

INNOVATION AWARDS



WINNER

Wireless Hydronic Balancing Kit

Series 490W

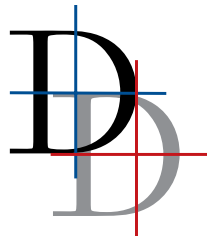

The ACHR News is the leading trade magazine in the heating, ventilating, air conditioning, and refrigeration industries.

GOLD

- HVAC Mobile Meter® Software Test Instrument App
- PredictAir™ Application Software
- Air Velocity Transmitter | **Series AVUL**

SILVER

- Universal Handheld Test Instrument | **Model UHH2**
- Wireless Hydronic Balancing Kit | **Series 490W**
- Hydronic Application Software

BRONZE

- SMART Air Hood® Balancing Instrument | **Series SAH**
- Hydronic Differential Pressure Manometer | **Series 490A**
- Insertion Electromagnetic Flow Transmitter | **Series IEF**

Product Applications X-XIV

PRESSURE

SELECTION GUIDES 1-14

- Differential Pressure**
 - Pressure Gages 1-2
 - Bezels 1
 - Accessories 2
 - Pressure Gages/Switches 3-4
- Low Differential Pressure - Pressure Switches** 3-6
- Low Differential Pressure - Non-Indicating**
 - Pressure Transmitters and Transducers 5
- Low Differential Pressure - Indicating**
 - Pressure Transmitters and Transducers 7-8
- Wet-Wet Differential Pressure**
 - Pressure Transmitters and Transducers 7-8
- Single Pressure - Pressure Gages** 9
- High Single Pressure - Indicating**
 - Pressure Transmitters and Transducers 9
- Digital Single Pressure - Pressure Gages** 10
- Single Pressure - Pressure Switches** 11-12
- High Single Pressure - Non-Indicating**
 - Pressure Transmitters and Transducers 13-14

TYPICAL APPLICATIONS 15-16

TEMPERATURE

SELECTION GUIDES 17-18

- Dial - Thermometers** 17
- Limit Control - Digital Temperature Switches** 17
- PID Loop Controllers - Temperature and Process Controllers** 18
- Heating and Cooling/Refrigeration Control**
 - Digital Temperature Switches 18

TYPICAL APPLICATIONS 19-20

TEST & DATA

SELECTION GUIDES 21-24

- Digital - Manometers** 21-22
- Thermo - Anemometers** 23
- Calibration - Pumps** 24

TYPICAL APPLICATIONS 25-26

AIR QUALITY

SELECTION GUIDES 27-28

- Air Velocity - Transmitters** 27
- Humidity and Humidity/Temperature - Transmitters** 27-28
- Carbon Monoxide - Sensors** 28

TYPICAL APPLICATIONS 29-30

FLOW

SELECTION GUIDES 31-37

- General Purpose Panel Mount - Flowmeters** 31
- Corrosive Media - Flowmeters** 31
- General Purpose In-Line - Flowmeters** 32
- Industrial - Flowmeters** 32
- Paddle and Thermal Style - Flow Switches** 33
- Piston Style - Flow Switches** 34
- Paddle Wheel/Turbine/Multi-Jet - Flow Transmitters** 35
- Flow - Water Meters** 35
- Ultrasonic - Flow Transmitters** 36
- Flow - Heat Meters** 36
- Electromagnetic, In-line/Insertion - Flow Transmitters** 37

TYPICAL APPLICATIONS 38-40

LEVEL

SELECTION GUIDES 41-44

- Liquid - Level Switches** 41-42
- Bulk - Level Switches** 43-44
- Submersible - Level Transmitters** 43
- Capacitive, Ultrasonic and Float - Level Transmitters** 44

TYPICAL APPLICATIONS 45-46

PROCESS CONTROL

SELECTION GUIDES 47-50

- Panel Meters - Displays** 47-48
- Switches and Transformers - Current Sensors** 47-48
- Power Supplies and Transformers - Power Converters** 49
- Powder, Bulk, Dust Collection, and Pneumatic Conveying Sensors**
 - Particulate Sensors 49
 - Dust Collector Pulse Valve Controllers - Timers 50

TYPICAL APPLICATIONS 51-52

VALVES

SELECTION GUIDES 53-56

- 2-Way - Automated Ball Valves** 53-54
- 3-Way - Automated Ball Valves** 53
- Positioners** 54
- Hand Lever - Ball Valves** 55-56
- Position Indicators/Switches/Transmitters** 55-56

TYPICAL APPLICATIONS 57



2021 DWYER CATALOG
AVAILABLE NOW!

download or request your copy today

online: dwyer-inst.com/catalogrequest | email: lit@dwyermail.com

AIR HANDLER

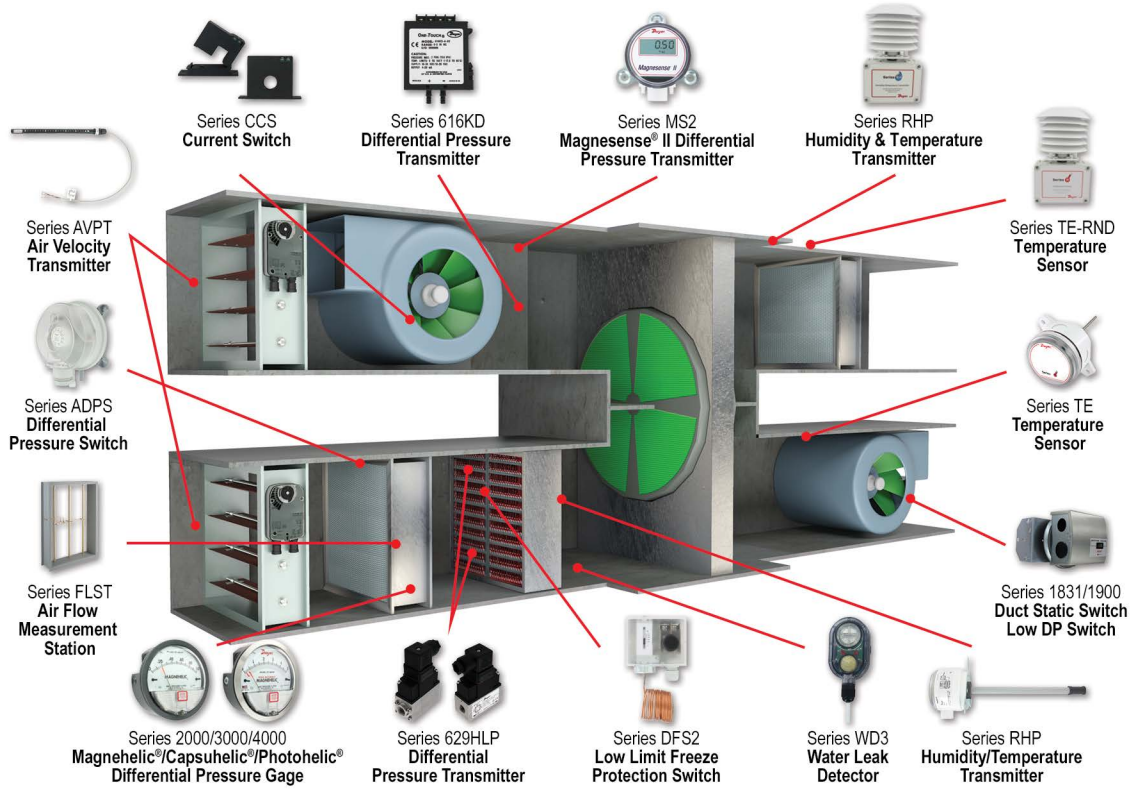

CHILLER PLANT

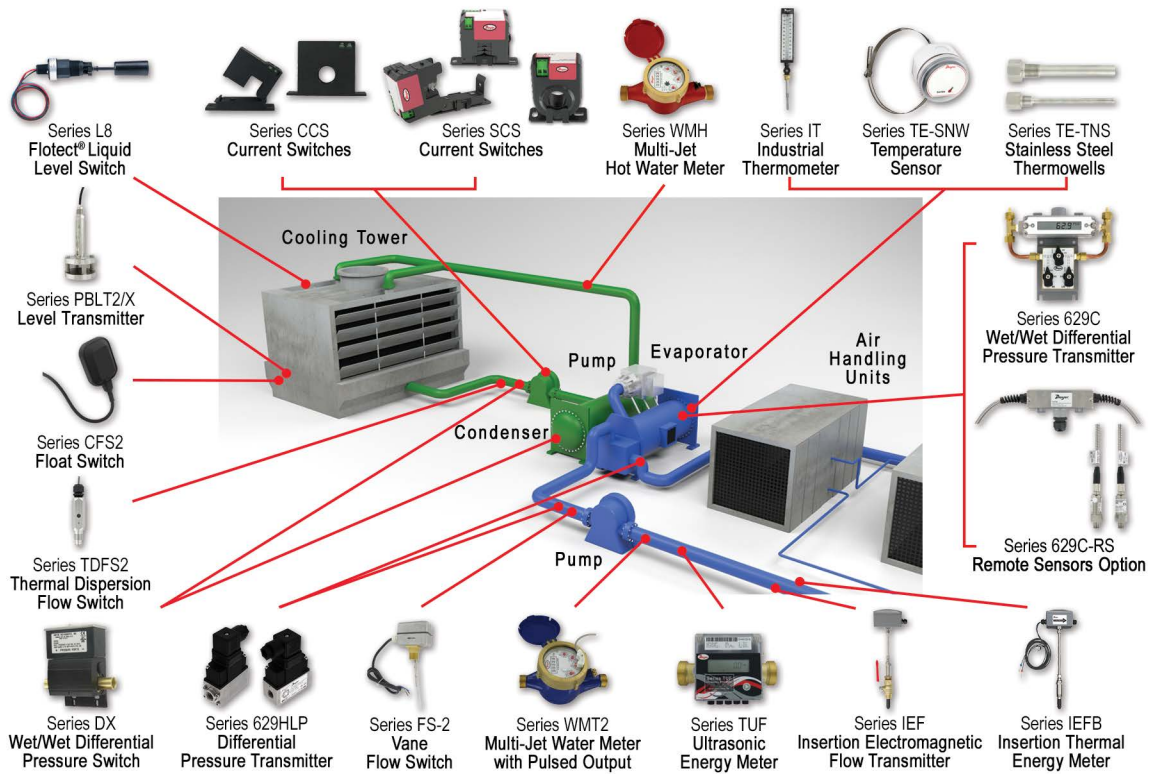

TERMINAL UNIT

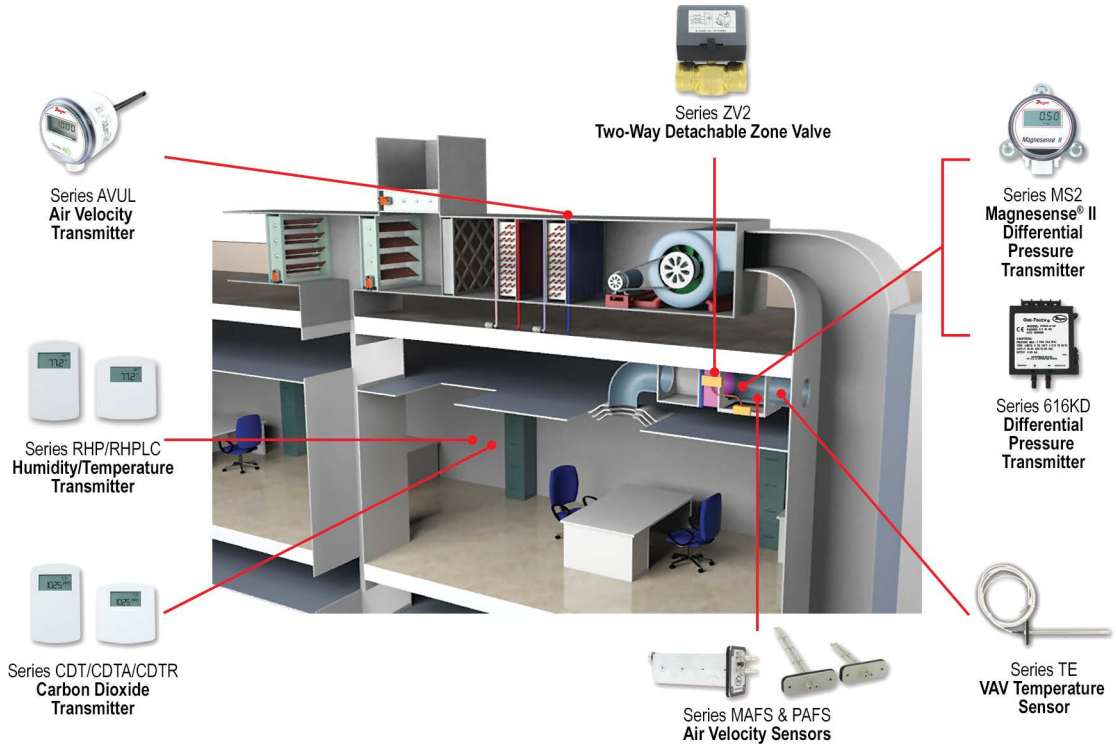

ISOLATION ROOM

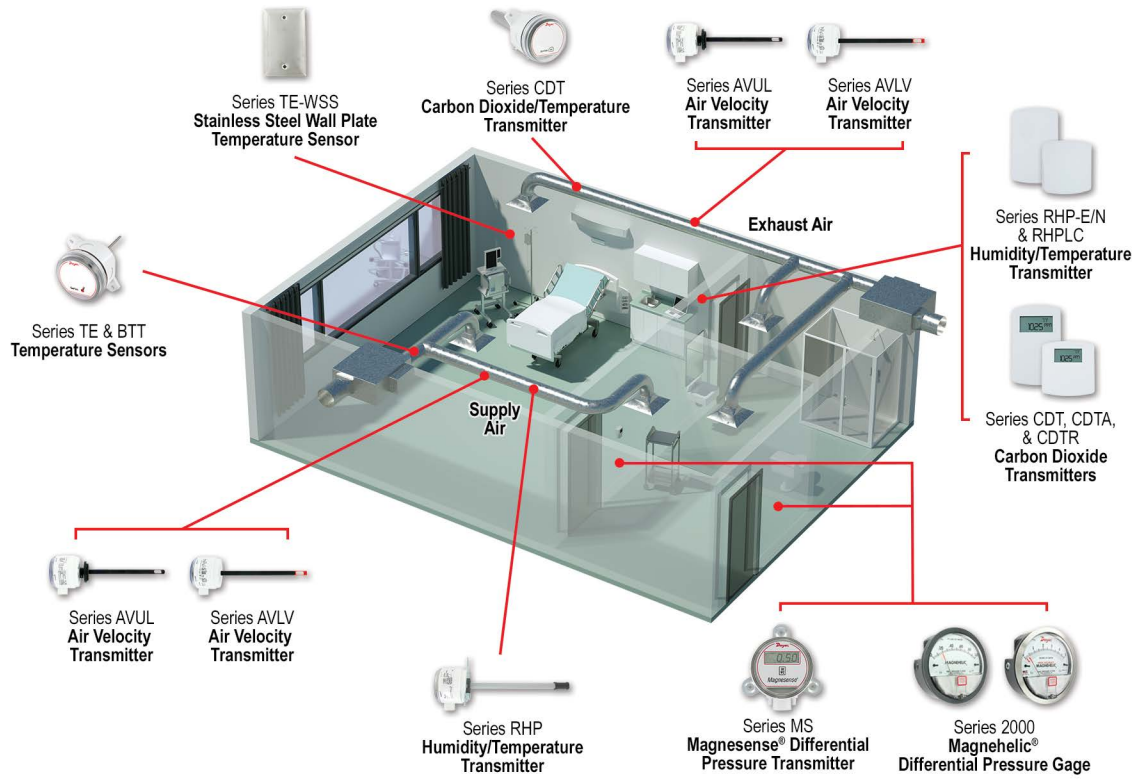

BUILDING BALANCING

Series 160G & DP3 Air Flow Grid & Differential Pressure Module

Series SAH SMART Air Hood® Balancing Instrument & Application Software

Mobile Meter® HVAC Software App

Series 160F Pitot Tube

Series PUB Portable Ultrasonic Flowmeter Kit

Model TAC-L Portable Digital Tachometer

Series 490W Hydronic Differential Pressure Manometer

Series 477AV Digital Manometer

Series 478A Digital Manometer

HVAC TESTING

Series 160F Pitot Tube

Model TAC-L Portable Digital Tachometer

Series 477AV Handheld Digital Manometer

Series 471B Thermo-Anemometer

Series WNT Multi-Jet NSF Certified Water Meter

Series WMH Multi-Jet Hot Water Meter

Series TUF Ultrasonic Energy Meter

Series IEFB Insertion Thermal Energy Meter

STANDARD TERMS & CONDITIONS OF SALE

DWYER INSTRUMENTS, INC. - TERMS AND CONDITIONS OF SALE – MARCH 15, 2017

- 1. Prices and Specifications** are subject to change without notice.
- 2. Shipping dates** are approximate. They are dependent upon credit approval and subject to delays beyond our control.
- 3. Terms:** Net 30 days to companies with established credit rating. In the event Buyer fails to fulfill previous terms of payment, or in case Seller shall have any doubt at any time as to Buyer's financial responsibility, Seller may decline to make further deliveries except upon receipt of cash in advance or other special arrangements.
- 4. Point and Title:** All material is sold EXW Ex Works Dwyer Instruments, Inc. Title to all material sold shall pass to buyer upon delivery by Seller to carrier at shipping point.
- 5. State and Local Taxes:** Any taxes which the Seller may be required to pay or collect upon or with respect to the sale, purchase, delivery, use or consumption of any of the material covered hereby shall be for the account of the Buyer and shall be added to the purchase price.
- 6. Special tooling,** dies, silk screens and molds acquired specially to produce goods for Buyer remain the property of Dwyer Instruments, Inc., and may not be removed. They will be maintained in good condition for a minimum period of three years from the date of the original purchase order.
- 7. Trade Compliance:** Buyer acknowledges that the products, software, and technology, including technical information and documents (collectively "Items"), of Dwyer Instruments, Inc., are subject to regulation by agencies of the U.S. government including, but not limited to, the U.S. Department of Commerce. Buyer shall comply with the Export Administration Regulations (EAR) and all applicable U.S. laws and regulations regarding the sale, delivery and transfer of said Items. Buyer shall not, without first obtaining the required licenses, authorizations or approvals from the appropriate U.S. government agency; (i) export, re-export, transfer or divert any Item directly or indirectly to any country or national resident thereof, or any person, entity or country that has restrictions imposed upon them by the U.S. government, (ii) engage in, or knowingly sell to any party engaged in activity related to the development, production, use, testing, or maintenance of Weapons of Mass Destruction, including uses related to nuclear, missile, chemical or biological warfare, or (iii) engage in, or knowingly sell to any party engaged in activity related to the development, production, use, or maintenance of any safeguarded or unsafeguarded nuclear fuel facility or components for such facilities. Buyer shall fully cooperate with Seller, without charge, in any official audit or inspection by an authorized agent, official, employee, or accredited representative of the U.S. government. Buyer shall indemnify and hold Seller harmless from, or in connection with, any violation of this Section by Buyer, its employees, consultants, agents, or customers. The obligations, requirements and claims described herein shall survive the expiration of any business relationship with Dwyer Instruments, Inc., including its divisions, subsidiaries and affiliated companies.
- 8. Distribution:** Products sold to any entity located in the U.S. must remain in the U.S. unless a Global Distribution Agreement is in force with said entity. OEM's are excluded from this requirement. Those who violate this term are subject to a reduction of discount, loss of discount, or exclusion from purchasing future products. If you want to be a Global Distributor, please contact your Global Sales Manager in your region.
- 9. Limited Warranty:** The Seller warrants all Dwyer instruments and equipment to be free from defects in workmanship or material under normal use and service for a period of one year from date of shipment. Products qualifying for an extended warranty period will have the extended warranty as expressly indicated on the catalog page, web page, IOM, or will be covered by a specific written agreement that is (i) approved by an officer of Dwyer Instruments, Inc. and (ii) defines the warranty period. If no express statement of extended warranty is made, then the standard 1 year warranty applies. The Extended Limited Warranty only applies to products manufactured after April 1, 2017. The Warranty period extends from the date of shipment to the initial customer and not the project installation date or use.

Specific warranty exclusions include, but are not limited to:

- Specific product components not covered by the extended warranty:
 - o Humidity Sensors
 - o Batteries
 - o Electro-Chemical Gas Sensors
 - o Snap Switches
 - o Any component which exceed its normal life cycle
 - o Other Specific items added as required.
- Normal or excessive wear and tear is not cause for warranty replacement.
- Products not properly maintained, operated, installed, or use in an application not suited for the product.
- Modifications, alterations, changes, or additions outside those which are required for normal operation.
- Failure to notify Dwyer of any defect within a reasonable time.
- Damage which the customer has not taken timely action to minimize or mitigate.
- Products on which the labels, markings, nameplates, etc. have been tampered with.
- Products which contain broken factory seals or have been tampered with shall void warranty.



Liability under this warranty is limited to repair or replacement EXW Ex Works Dwyer Instruments, Inc. of any parts which prove to be defective within that time or repayment of the purchase price at the Seller's option. All products must be returned to the Seller, transportation prepaid, unless other arrangements have been pre-approved by Seller. All technical advice, recommendations and services are based on technical data and information which the Seller believes to be reliable and are intended for use by persons having skill and knowledge of the business, at their own discretion. In no case is Seller liable beyond replacement of equipment EXW Ex Works Dwyer Instruments, Inc. or the full purchase price. This warranty does not apply if the maximum ratings label is removed or if the instrument or equipment is abused, altered, used at ratings above the maximum specified, or otherwise misused in any way.

THIS EXPRESS LIMITED WARRANTY IS IN LIEU OF AND EXCLUDES ALL OTHER REPRESENTATIONS MADE BY ADVERTISEMENTS OR BY AGENTS AND ALL OTHER WARRANTIES, BOTH EXPRESS AND IMPLIED. THERE ARE NO IMPLIED WARRANTIES OF MERCHANTABILITY OR OF FITNESS FOR A PARTICULAR PURPOSE FOR GOODS COVERED HEREUNDER.

- 10. Buyer's Remedies:** THE BUYER'S EXCLUSIVE AND SOLE REMEDY ON ACCOUNT OF OR IN RESPECT TO THE FURNISHING OF NON-CONFORMING OR DEFECTIVE MATERIAL SHALL BE TO SECURE REPLACEMENT THEREOF AS AFORESAID. THE SELLER SHALL NOT IN ANY EVENT BE LIABLE FOR THE COST OF ANY LABOR EXPENDED ON ANY SUCH MATERIAL OR FOR ANY SPECIAL, DIRECT, INDIRECT, CONSEQUENTIAL OR INCIDENTAL DAMAGES TO ANYONE BY REASON OF THE FACT THAT IT SHALL HAVE BEEN NON-CONFORMING OR DEFECTIVE.
- 11. Acceptance:** All orders shall be subject to the terms and conditions contained or referred to in the Seller's quotation, acknowledgment, and to those listed here and to no others whatsoever. By placing an order you accept our terms and conditions. No waiver, alteration or modification of these terms and conditions shall be binding unless in writing and signed by an executive officer of the Seller. All orders are subject to written acceptance by Dwyer Instruments, Inc., Michigan City, Indiana, U.S.A.





DIFFERENTIAL PRESSURE

Pressure Gages

			
SERIES	2000*	DM-1000*	2-5000*
Ranges	-0.05 to 0.2 in w.c. (-10 to 50 Pa) up to 0 to 30 psi (0 to 30 kPa)	0.25 to 100 in w.c. (60 Pa to 24.88 kPa) (Bi-directional ranges available)	0.5 in w.c. to 5 psi (125 Pa to 3 kPa)
Service	Air and non-combustible, compatible gases	Air and non-combustible, compatible gases	Air and compatible gases
Wetted Materials	Consult factory	Consult factory	Consult factory
Housing	Die cast aluminum case and bezel	Glass filled plastic	Glass filled nylon
Lens	Clear acrylic	N/A	Clear acrylic
Accuracy	±2 to 4% FS for most models. ±1 to 2% FS with HA option	±1% FS (2% FS for ranges 1 in w.c. and below)	±5% FS
Pressure Limits	-20" Hg to 15 psig (-0.677 bar to 1.034 bar); MP option: 35 psig (2.41 bar); HP option: 80 psig (5.52 bar).	2 psi (14 kPa) for ≤5 in w.c. 11 psi (75 kPa) for ≥10 in w.c.	30 psig (2.067 bar)
Temperature Limits	20 to 140°F (-6.67 to 60°C)	0 to 140°F (-18 to 60°C)	20 to 120°F (-6.67 to 48.9°C)
Process Connection	1/8" female NPT duplicate high and low pressure taps	1/8" (3 mm) ID tubing	Barbed for 3/16" ID tubing or 1/8" male NPT
Enclosure Rating	N/A	NEMA 4X (IP66)	N/A

DIFFERENTIAL PRESSURE

Bezels

				
SERIES	2000-SS*	2000-SB*	2000-CB*	DH3-SS*/3000MR(S)-SS*/605-SS*
Accessory	Bezel	Bezel	Bezel	Bezel
Material	304 brushed stainless steel	304 stainless steel	Chrome plated aluminum	304 brushed stainless steel
Dimensions	4-3/4" (120.7 mm) OD	4-3/4" (120.7 mm) OD	4-3/4" (120.7 mm) OD	4-3/4" (120.7 mm) OD
Aesthetics/Function	Tapered brushed/matte SS finish	Electro polished Ra 16	Chrome finish	Tapered brushed/matte SS finish
Part Sold Separately	Yes	Yes	Yes	Yes
Part Number	420141-40	420141-10	420141-00	815999-10

***CALIBRATION SERVICES AVAILABLE**

These Selection Guides are for quick comparison of similar products. Please refer to the catalog page number referenced for complete product information and specifications.



DIFFERENTIAL PRESSURE

Pressure Gages

			
SERIES	4000*	PTGD*	PFG2*
Ranges	0 to 5 in w.c. up to 0 to 20 psid	5 to 150 psid (0.25 to 10 bar)	5 to 25 psid
Service	Air and compatible gases and oil based liquids	Compatible gases and liquids	Liquids/gases compatible with SS, GFN, and fluoropolymer
Wetted Materials	Consult factory	Aluminum or 316 SS piston; Buna-N, PTFE, or ceramic magnet seals	Aluminum mounting block
Housing	Die cast aluminum with impregnated hard coating	Aluminum or 316 SS	Glass filled nylon
Lens	N/A	Acrylic	Polyester
Accuracy	±3% FS (±2% or 4% for certain ranges)	±2% FS	±5% FS
Pressure Limits	-20" Hg to 500 psig (-0.68 to 34.4 bar)	Aluminum: 3000 psi (206 bar); SS: 6000 psi (413 bar)	300 psig (20.7 bar)
Temperature Limits	20 to 200°F (-6.7 to 93.3°C)	N/A	200°F (93°C)
Process Connection	1/4" female NPT duplicate high and low pressure taps	1/4" female NPT	1/8" female NPT
Enclosure Rating	N/A	N/A	N/A

DIFFERENTIAL PRESSURE

Accessories

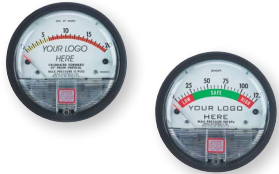
				
SERIES	AHU1/2	A-464	A-320-A	Scale Customization
Accessory	Surface mounting kit	Flush mounting kit	Enclosure	Customized logos/company name
Material	ABS plastic	White ABS plastic	ABS	Printed on aluminum scale
Dimensions	4-1/2" x 4-1/2"	6-1/2" x 6-1/2"	4-23/32" x 3-37/64" x 6-19/64"	As per customer requirement
Enclosure Rating	N/A	N/A	NEMA 1 (IP10)	N/A
Mounting Orientation	Surface	Flush	Wall	N/A
Aesthetics/Function	Quick Install accessory	Cleanroom mount	Quick install kit	Customize your application
Part Sold Separately	Yes	Yes	Yes	N/A
Part Number	A-607/A-607 with A-481	A-464	A-320-A	N/A

***CALIBRATION SERVICES AVAILABLE**

These Selection Guides are for quick comparison of similar products. Please refer to the catalog page number referenced for complete product information and specifications.

DIFFERENTIAL PRESSURE

Pressure Gages/Switches

				
SERIES	DHII*	DH*	DH3*	A3000*
Ranges	0.25 to 100 in w.c. (60 Pa to 24.88 kPa) (Bi-directional ranges available)	0.25 to 100 in w.c. (60 Pa to 24.88 kPa) (Bi-directional ranges available)	0.25 to 100 in w.c. (60 Pa to 24.88 kPa) (Bi-directional ranges available)	0 to 0.25 in w.c. (0 to 60 Pa) up to 0 to 150 in w.c. (0 to 30 kPa)
Service	Air and non-combustible, compatible gases	Air and non-combustible, compatible gases	Air and non-combustible, compatible gases	Air and non-combustible, compatible gases
Wetted Materials	Consult factory	Consult factory	Consult factory	Consult factory
Housing	Aluminum, glass	ABS plastic, UL approved 94 V-0	Die cast aluminum case and bezel	N/A
Switch Type	(2) SPDT	(2) SPDT	(2) SPDT	(2) DPDT
Accuracy	±0.5% FS	±0.5% FS	±0.5% FS (±1% or ±1.5 for certain ranges)	±2% FS (±3% or 4% for certain ranges)
Pressure Limits	2 psi (≤2.5 in w.c.); 5 psi (5 to 50 in w.c.); 9 psi (100 in w.c.)	2 psi (≤2.5 in w.c.); 5 psi (5 to 50 in w.c.); 9 psi (100 in w.c.)	2 psi (≤2.5 in w.c.); 5 psi (5 to 50 in w.c.); 9 psi (100 in w.c.)	-20" Hg to 25 psig (-0.677 bar to 1.72 bar); MP option: 35 psig (2.41 bar); HP option: 80 psig (5.52 bar).
Temperature Limits	32 to 140°F (0 to 60°C)	32 to 140°F (0 to 60°C)	32 to 140°F (0 to 60°C)	20 to 120°F (-6.67 to 48.9°C)
Process Connection	1/8" female NPT	Compression fitting for 1/8" ID tubing or barbed fitting for 3/16" ID tubing	1/8" female NPT	1/8" female NPT
Enclosure Rating	NEMA 4 (IP66)	NEMA 4X (IP66)	N/A	N/A

LOW DIFFERENTIAL PRESSURE

Pressure Switches





				
SERIES	ADPS	EDPS	1800	1900
Set Point Range	.08 to 20 in w.c. (20 to 5000 Pa)	.08 to 20 in w.c. (20 to 5000 Pa)	.07 to 85 in w.c. (.017 to 21 kPa)	.07 to 20 in w.c. (.017 to 5 kPa)
Service	Compatible gases	Compatible gases	Compatible gases	Compatible gases
Wetted Materials	Silicone, PA 6.6, and Polystyrene	Silicone, PA 6.6, and materials UL 94 V-0 rated	Consult factory	Consult factory
Temperature Limits	-4 to 185°F (-20 to 85°C)	-4 to 185°F (-20 to 85°C)	-30 to 180°F (-34 to 82°C)	-30 to 180°F (-34 to 82°C)
Pressure Limits	40 in w.c. (10 kPa)	40 in w.c. (10 kPa)	10 psig (69 kPa)	45 in w.c. (11.2 kPa)
Power Requirement	None	None	None	None
Repeatability	1%	1%	2%	3%
Adjustable Deadband	No	No	No	No
Set Point Indication	Yes	Yes	No	No
Enclosure Rating	GP	UL 94 V-0 rated	GP, WP, or EXP	GP, WP, or EXP
Switch Type	SPDT	SPDT	SPDT	SPDT
Multiple Stages	No	No	No	No
Process Connection	Hose connection for 5/16" OD and 1/4" ID tubing	Hose connection for 5/16" OD and 1/4" ID tubing	1/8" female NPT	1/8" female NPT

*CALIBRATION SERVICES AVAILABLE

These Selection Guides are for quick comparison of similar products. Please refer to the catalog page number referenced for complete product information and specifications.





DIFFERENTIAL PRESSURE

Pressure Gages/Switches

				
SERIES	43000*	3000MR*	3000MRS*	MP*
Ranges	0 to 0.5 in w.c. up to 0 to 500 in w.c.	0 to 0.25 in w.c. (0 to 60 Pa) up to 0 to 100 in w.c. (0 to 4 kPa)	0 to 0.25 in w.c. (0 to 60 Pa) up to 0 to 100 in w.c. (0 to 4 kPa)	0 to 0.5 in w.c. (0 to 125 kPa) up to 0 to 20 in w.c. (0 to 3 kPa)
Service	Compatible gases and liquids	Air and non-combustible compatible gases	Air and non-combustible compatible gases	Air and non-combustible, compatible gases
Wetted Materials	Consult factory	Consult factory	Consult factory	Consult factory
Housing	N/A	N/A	N/A	N/A
Switch Type	(2) DPDT	SPDT	Solid state relay	(2) SPDT
Accuracy	±3% FS (±4% for certain ranges)	±2% FS (±3% or 4% for certain ranges)	±2% FS (±3% or 4% for certain ranges)	±5% FS
Pressure Limits	-20" Hg to 500 psig (-0.677 bar to 34.5 bar)	-20" Hg to 25 psig (-0.677 bar to 1.72 bar)	-20" Hg to 25 psig (-0.677 bar to 1.72 bar)	30 psig (2.067 bar)
Temperature Limits	20 to 120°F (-6.67 to 48.9°C)	20 to 120°F (-6.67 to 48.9°C)	20 to 120°F (-6.67 to 48.9°C)	20 to 120°F (-6.67 to 49°C)
Process Connection	1/4" female NPT	1/8" female NPT	1/8" female NPT	Barbed for 3/16" ID tubing or 1/8" male NPT
Enclosure Rating	N/A	N/A	N/A	N/A

LOW DIFFERENTIAL PRESSURE

Pressure Switches

				
SERIES	MDS	MDA	1831	1640
Set Point Range	.5 to 50 in w.c. (.12 to 12.5 kPa)	.1 to 100 in w.c. (.25 to 249.1 mbar)	2.5 to 23 in w.c. (.62 to 5.7 kPa)	.01 to 12 in w.c. (.003 to 3 kPa)
Service	Air or compatible fluids on "high side"	Air or compatible fluids on "high side"	Compatible gases	Compatible gases
Wetted Materials	Polycarbonate and polyurethane	Polycarbonate and polyurethane	Consult factory	Consult factory
Temperature Limits	40 to 150°F (4 to 66°C)	40 to 150°F (4 to 66°C)	-30 to 180°F (-34 to 82°C)	-30 to 110°F (-34 to 43°C)
Pressure Limits	15 psig (1 bar)	15 psig (1 bar)	10 psig (69 kPa)	10 psig (69 kPa)
Power Requirement	None	None	None	None
Repeatability	Consult factory	Consult factory	4%	Consult factory
Adjustable Deadband	No	No	No	No
Set Point Indication	No	No	No	Yes
Enclosure Rating	GP	GP	GP	GP, WP, or EXP
Switch Type	SPST NO	SPST NO	DPDT	SPDT
Multiple Stages	No	No	No	Yes
Process Connection	Hose barb for 1/8"-3/16" ID tubing	Smooth port for 1/8" ID tubing	1/8" female NPT	1/8" female NPT





***CALIBRATION SERVICES AVAILABLE**

These Selection Guides are for quick comparison of similar products. Please refer to the catalog page number referenced for complete product information and specifications.





LOW DIFFERENTIAL PRESSURE

Pressure Switches

				
SERIES	1620	1630	PG	1950
Set Point Range	.15 to 24 in w.c. (.04 to 6 kPa)	.05 to 12 in w.c. (.012 to 3 kPa)	1 in w.c. to 5 psig (.25 kPa to 3.4 bar)	.03 to 20 in w.c. (.007 to 5 kPa)
Service	Compatible gases	Compatible gases	Compatible gases	Compatible gases
Wetted Materials	Consult factory	Consult factory	Fairprene, brass, steel, and aluminum	Consult factory
Temperature Limits	-30 to 130°F (-34 to 54°C)	-30 to 110°F (-34 to 43°C)	-10 to 180°F (-23 to 82°C)	-40 to 140°F (-40 to 60°C)
Pressure Limits	50 in w.c. (12.41 kPa)	10 psig (69 kPa)	Consult factory	45 in w.c. (11.2 kPa)
Power Requirement	None	None	None	None
Repeatability	1%	1%	1%	Consult factory
Adjustable	No	No	No	No
Deadband				
Set Point Indication	No	Yes	Yes	No
Enclosure Rating	GP and WP	GP and WP	GP, WP, or EXP	WP and EXP
Switch Type	(2) SPDT	SPDT	SPDT or DPDT	SPDT
Multiple Stages	Yes	No	No	No
Process Connection	1/8" female NPT	1/8" female NPT	1/8" female and 1/2" male NPT	1/8" female NPT

LOW DIFFERENTIAL PRESSURE - NON-INDICATING

Pressure Transmitters and Transducers

			
SERIES	616KD*	668B/D*	608*
Ranges	1 to 20 in w.c. (250 to 5000 Pa) to 5000 Pa (Bi-directional available)	.1 to 100 in w.c. (25 to 25000 Pa) (Bi-directional available)	0.1 to 25 in w.c. (25 to 6200 Pa) (Bi-directional available)
Accuracy	616KD-A: ±0.25% FS; 616KD-B: ±1% FS; 616KD-C: ±2% FS	±0.8% FS	±0.5% or ±0.25% FS
Wetted Materials	Consult factory	Consult factory	Consult factory
Comp. Temp. Limits	20 to 122°F (-6.67 to 50°C)	40 to 170°F (4.4 to 77°C)	0 to 160°F (-18 to 71°C)
Oper. Temp. Limits	0 to 140°F (-17.8 to 60°C)	0 to 170°F (-18 to 77°C)	-20 to 185°F (-28 to 85°C)
Output Signal	4-20 mA or field selectable 0 to 10/0 to 5/2 to 10/1 to 5 V	4-20 mA, 0-10 VDC, or 0-5 VDC	4-20 mA
Elec. Connection	Screw-type terminal block	Screw-type terminal block	Screw-type terminal block, Two 1/2" female NPT conduit
Process Connection	Barbed for 1/8" and 3/16" ID rubber or vinyl tubing	3/16" OD barbed brass for 1/8" ID push-on tubing	1/4" female NPT
Enclosure Rating	NEMA 1 (IP20)	UL 94 V-0 rated	NEMA 4X (IP66)

*CALIBRATION SERVICES AVAILABLE

These Selection Guides are for quick comparison of similar products. Please refer to the catalog page number referenced for complete product information and specifications.

LOW DIFFERENTIAL PRESSURE

Pressure Switches





SERIES	1950G	H3	DX
Set Point Range	.07 to 20 in w.c. (.017 to 5 kPa)	180 in w.c. to 200 psid (0.5 to 13.5 bar)	2.5 to 75 psi (.17 to 5.2 bar)
Service	Compatible gases	Compatible liquids or gases	Compatible liquids or gases
Wetted Materials	Consult factory	Aluminum/Nitrile or SS/ Fluoroelastomer	Brass and fluoroelastomer
Temperature Limits	0 to 140°F (-18 to 60°C)	-4 to 220°F (-20 to 104°F)	30 to 140°F (-1 to 60°C)
Pressure Limits	45 in w.c. (11.2 kPa)	1500 psig (103 bar)	200 psig (13.8 bar)
Power Requirement	24 VDC, 120 or 240 VAC	None	None
Repeatability	Consult factory	Consult factory	2%
Adjustable Deadband	No	No	Yes
Set Point Indication	No	No	No
Enclosure Rating	WP and EXP	EP	WP
Switch Type	SPDT	SPDT or DPDT	SPDT
Multiple Stages	No	No	No
Process Connection	1/8" female NPT	1/8" female NPT	1/4" female NPT







LOW DIFFERENTIAL PRESSURE - INDICATING

Pressure Transmitters and Transducers

			
SERIES	616W*	DM-2000*	605*
Ranges	6 in w.c. to 2.5 kPa	.1 to 5 in w.c. (Bi-directional available)	Vacuum, .5 to 50 in w.c. (60 to 1500 Pa)
Accuracy	±0.25% FS, display accuracy ±0.5%	±1% FS	±0.5% or ±2% FS
Wetted Materials	Consult factory	Consult factory	Consult factory
Comp. Temp. Limits	N/A	N/A	32 to 120°F (0 to 48.9°C)
Oper. Temp. Limits	0 to 150°F (-17.8 to 66°C)	20 to 120°F (-7 to 49°C)	20 to 120°F (-6.67 to 48.9°C)
Output Signal	4-20 mA (2-wire), 0-5 VDC, or 0-10 VDC (3-wire)	4-20 mA	4-20 mA
Elec. Connection	3-wire terminal block for 16 to 26 AWG	Screw-type terminal block	Screw-type terminal block
Process Connection	Barbed for 1/8" and 3/16" ID rubber or vinyl tubing	1/8" ID tubing	1/8" female NPT
Enclosure Rating	NEMA 4X (IP66)	N/A	N/A

WET-WET DIFFERENTIAL PRESSURE

Pressure Transmitters and Transducers

				
SERIES	3100D*	636D*	629C*	629C-3V*
Ranges	6 in w.c. to 0-1000 psig	15 to 300 psi	5 to 500 psid (0.5 to 30 bar)	5 to 500 psid (0.5 to 30 bar)
Accuracy	±0.075% FS	±0.5% FS	±0.50% FS	±0.50% FS
Wetted Materials	316L SS	316L SS	316, 316L SS	316, 316L SS, Brass 360, Copper, Reinforced acetal copolymer
Comp. Temp. Limits	N/A	-20 to 180°F (-29 to 82°C)	0 to 175°F (-18 to 79°C)	0 to 175°F (-18 to 79°C)
Oper. Temp. Limits	-40 to 185°F (-40 to 85°C)	-40 to 212°F (-40 to 100°C)	0 to 200°F (-18 to 93°C)	0 to 200°F (-18 to 93°C)
Output Signal	4-20 mA or HART® Communication	4-20 mA or 1 to 5 VDC	2-wire: 4-20 mA; 3-wire: Selectable 0-5, 1-5, 0-10, or 2-10 VDC	2-wire: 4-20 mA; 3-wire: Selectable 0-5, 1-5, 0-10, or 2-10 VDC
Elec. Connection	(2) 1/2" female NPT conduit, screw terminal	2' (61 cm) cable, 3/4" female NPT conduit	Screw-type removable terminal block; 1/2" female NPT conduit	Screw-type removable terminal block; 1/2" female NPT conduit
Process Connection	1/4" female NPT	1/2" female NPT	1/4" female NPT	1/4" female NPT
Enclosure Rating	NEMA 4X (IP66)	NEMA 4 (IP66)	NEMA 4X (IP66)	Non-LCD designed to meet NEMA 4X (IP66)

*CALIBRATION SERVICES AVAILABLE

HART® is a registered trademark of Hart Communication Foundation

These Selection Guides are for quick comparison of similar products. Please refer to the catalog page number referenced for complete product information and specifications.

LOW DIFFERENTIAL PRESSURE - INDICATING

Pressure Transmitters and Transducers



SERIES	MS2*	ISDP*
Ranges	0.1 in w.c. to 28 in w.c. (25 Pa to 6975 Pa) (Bi-directional available)	0.1 to 100 in w.c. (Bi-directional available)
Accuracy	±1% or ±2% FS	±0.5% FS
Wetted Materials	Consult factory	Consult factory
Comp. Temp. Limits	N/A	32 to 140°F (0 to 60°C)
Oper. Temp. Limits	0 to 150°F (-18 to 66°C)	32 to 140°F (0 to 60°C)
Output Signal	4-20 mA (2-wire), 0-5 VDC, 0-10 VDC (3-wire)	4-20 mA DC
Elec. Connection	3-wire terminal block for 16 to 22 AWG	M-12 4-pin connector
Process Connection	3/16" I.D. tubing (5 mm ID); Max OD 9 mm	1/8" female NPT
Enclosure Rating	NEMA 4X (IP66)	NEMA 4X (IP66)

WET-WET DIFFERENTIAL PRESSURE

Pressure Transmitters and Transducers



SERIES	629HLP*	647*	645*	WWDP*
Ranges	15 to 90 psi (1 to 6 bar)	1 in w.c. to 0-30 psid (245 Pa to 0-2.0 bar)	1 to 100 psid (0.07 to 6.5 bar) (Bi-directional ranges available)	5 to 250 psi
Accuracy	±1% FS	±1% FS	±0.25% FS	±1% FS
Wetted Materials	304 SS	Brass, vinyl, glass-filled polyester, silicon, fluorosilicone	17-4 PH SS, Fluoroelastomer, Silicone	Consult factory
Comp. Temp. Limits	-5 to 60°C (23 to 140°F)	N/A	30 to 150°F (-1 to 65°C)	32 to 130°F (0 to 54°C)
Oper. Temp. Limits	-10 to 80°C (14 to 176°F)	32 to 122°F (0 to 50°C)	0 to 175°F (-18 to 80°C)	-4 to 185°F (-20 to 85°C)
Output Signal	4-20 mA, 0-10 VDC	4-20 mA	4-20 mA	Selectable 0-5, 0-10, and 0-5 VDC; 4-20 mA
Elec. Connection	Form A DIN 43650	Screw-type terminal block	Screw-type terminal block	1/2" conduit
Process Connection	1/4" female NPT, 1/4" female BSPT	1/8" female NPT	1/4" female NPT	1/8" female NPT internal
Enclosure Rating	IP65	N/A	NEMA 4X (IP66)	NEMA 4 (IP66)

*CALIBRATION SERVICES AVAILABLE

These Selection Guides are for quick comparison of similar products. Please refer to the catalog page number referenced for complete product information and specifications.

SINGLE PRESSURE

Pressure Gages



SERIES	LPG4/LPG5*	SGY & SGZ*	765*
Ranges	-235 to 160 in w.c. (-60 to 40 kPa)	-30" Hg to 1000 psi (-1 to 70 bar)	30" Hg to 20,000 psi (-100 to 135,000 kPa)
Service	Compatible gases/liquids	Compatible gases/liquids	Compatible gases/liquids
Wetted Materials	Brass, bronze or SS	Brass, bronze or SS	316L SS, Bourdon tube
Housing	LPG4: Drawn Steel; LPG5: Chrome plated	304 SS	Phenolic plastic with safety blow-out back
Accuracy	LPG4 ±1.5% FS; LPG5 ±3%-2%-3% FS	±1.5 to ±2.5% FS	±0.5% FS ANSI/ASME (Grade 2A)
Pressure Limits	100% FS	100% FS	110 to 125% FS
Temperature Limits	Ambient: -40 to 140°F (-40 to 60°C); LPG5 -4 to 140°F (-20 to 60°C)	-4 to 140°F (-20 to 60°C)	-40 to 200°F (-40 to 93°C)
Process Connection	1/4" male NPT	1/4" male NPT	1/4" or 1/2" male NPT
Enclosure Rating	N/A	NEMA 3 (IP54)	IP65 (NEMA 4)

HIGH SINGLE PRESSURE - INDICATING

Pressure Transmitters and Transducers



SERIES	DSGT*	EDA*	626/628-CB*	IWP	3200G*
Ranges	30 to 20,000 psig and compound ranges	20 to 3000 psig	Up to 300 psia, 8000 psig, 16 bar abs, 550 bar	30 to 1000 psig	-14.5 psig to 8500 psig
Accuracy	±0.25% FS	±1% FS	626: ±0.25% FS; 628: ±1% FS	±0.5% FS	±0.075% FS
Wetted Materials	17-4 SS, 316 SS	316L SS	316, 316L SS	304 and 316 SS	316L SS
Comp. Temp. Limits	N/A	32 to 122°F (0 to 50°C)	0 to 175°F (0 to 79°C)	-22 to 203°F (-30 to 95°C)	N/A
Oper. Temp. Limits	14 to 140°F (-10 to 60°C)	20 to 140°F (-6.6 to 60°C)	0 to 200°F (0 to 94°C)	32 to 158°F (0 to 70°C)	-40 to 185°F (-40 to 85°C)
Output Signal	4-20 mA	4-20 mA, 1-6 VDC, 1-5 VDC, 0-5 VDC, or 0-10 VDC	4-20 mA	4-20 mA	4-20 mA or HART® Communication
Elec. Connection	3' flying leads	Screw-type removable terminal blocks with (2) 1/2" female NPT conduit connections	Terminal block, 1/2" female NPT conduit	1/2" female NPT	(2) 1/2" female NPT conduit, screw terminal
Process Connection	1/2" male NPT	1/4" male NPT, 1/4" male BSPT, or 7/16" SAE	1/4" male or female NPT or BSPT	1/2" female NPT	1/2" female NPT
Enclosure Rating	NEMA 4X	NEMA 4X (IP66)	NEMA 4X (IP66)	IP65	NEMA 4X (IP66)

*CALIBRATION SERVICES AVAILABLE

HART® is a registered trademark of Hart Communication Foundation

These Selection Guides are for quick comparison of similar products. Please refer to the catalog page number referenced for complete product information and specifications.

DIGITAL SINGLE PRESSURE

Pressure Gages







SERIES	DPGA*	DPGW*	DPG-000*	DPG-100*	DPG-200*
Ranges	-30" Hg to 500 psig (-1.013 to 34.47 bar)	-30" Hg to 500 psig (-1.013 to 34.47 bar)	-14.7 to 8000 psig (-1.0 to 550 bar)	-14.7 to 8000 psig (-1.0 to 550 bar)	5 to 8000 psig (0.3 to 550 bar)
Service	Air and compatible gases	Compatible gases/liquids	Compatible liquids and combustible gases	Compatible liquids and combustible gases	Liquids and non-combustible compatible gases
Wetted Materials	316L SS, silicone sensor	316L SS	Type 316L SS	Type 316L SS	Type 316L SS
Housing	ABS plastic	ABS plastic	Polycarbonate front and back cover, anodized aluminum housing, polycarbonate overlay, Buna-N O-rings, 316L SS sensor construction	Polycarbonate front and back cover, anodized aluminum housing, polycarbonate overlay, Buna-N O-rings, 316L SS sensor construction	Polycarbonate front and back cover, anodized aluminum housing, polycarbonate overlay, Buna-N O-rings, 316L SS sensor construction
Accuracy	±1% FS	±1% FS	±0.5% FS	±0.25% FS	±0.25% FS
Pressure Limits	200% FS; 30 psig for vacuum models	200% FS; 30 psig for vacuum models	200% FS (≤1000 psi); 5000 psi (3000 psi); 7500 psi (5000 psi)	200% FS (≤1000 psi); 5000 psi (3000 psi); 7500 psi (5000 psi)	200% FS (≤1000 psi); 5000 psi (3000 psi); 7500 psi (5000 psi)
Temperature Limits	30 to 120°F (-1 to 49°C)	30 to 120°F (-1 to 49°C)	0 to 130°F (-18 to 55°C)	0 to 130°F (-18 to 55°C)	0 to 158°F (-18 to 70°C)
Process Connection	1/4" male NPT	1/4" male NPT	1/4" male NPT	1/4" male NPT	1/4" male NPT
Enclosure Rating	N/A	N/A	NEMA 4/4X (IP66)	NEMA 4/4X (IP66)	NEMA 4X (IP66)

***CALIBRATION SERVICES AVAILABLE**

These Selection Guides are for quick comparison of similar products. Please refer to the catalog page number referenced for complete product information and specifications.

SINGLE PRESSURE

Pressure Switches

						
SERIES	EDA*	DA/DS	SA1100	1000W/E	A1F	A1PS/A1VS
Set Point Range	20 to 3000 psig (1.38 to 206 bar)	30" Hg VAC to 8000 psig (762 mm Hg VAC to 551 bar)	10 to 500 psig (.7 to 34 bar)	5 to 1400 psig (.48 to 96.5 bar)	2 to 450 psig (.14 to 10.3 bar)	28" Hg VAC to 500 psig (711 mm Hg VAC to 34.5 bar)
Service	Compatible liquids or gases	Compatible liquids or gases	Compatible liquids or gases	Compatible liquids or gases	Compatible liquids or gases	Compatible liquids or gases
Wetted Materials	316 SS	Brass, 403 SS, or 316 SS	Aluminum, brass, or 316 SS with Buna-N or fluorocarbon	Aluminum or 316 SS with polyamide, 316 SS, or Teflon®	Fluorocarbon and 316 SS	Zinc and Buna-N
Temperature Limits	20 to 140°F (-6.6 to 60°C)	-10 to 180°F (-23 to 82°C)	-30 to 180°F (-35 to 77°C)	-30 to 170°F (-35 to 77°C)	-40 to 175°F (-40 to 80°C)	-31 to 185°F (-35 to 85°C)
Pressure Limits	4500 psig (310 bar)	8000 psig (551 bar)	3000 psig (207 bar)	3000 psig (207 bar)	750 psig (51 bar)	600 psig (41 bar)
Power Requirement	12-30 VDC/AC	None	None	None	None	None
Repeatability	0.5%	1%	Consult factory	Consult factory	Consult factory	Consult factory
Adjustable Deadband	Yes	Yes	Yes	No	No	No
Set Point Indication	Yes	Yes	Yes	Yes	Yes	Yes
Enclosure Rating	WP	GP, WP, or EXP	WP and EXP	WP or EXP	GP or WP	GP
Switch Type	(2) SPDT	SPDT or DPDT	SPDT or DPDT	SPDT or DPDT	SPDT	SPDT
Multiple Stages	No	Yes	No	No	No	No
Process Connection	1/4" male NPT	GP/WP: 1/4" male NPT or 1/2" male NPT; EXP: 1/2" male NPT and 1/4" female NPT	1/4" or 1/2" female NPT	1/4" female NPT	1/4" female and 1/2" male NPT	1/4" male NPT







*CALIBRATION SERVICES AVAILABLE

Teflon® is a registered trademark of E. I. DuPont De Nemours and Company

These Selection Guides are for quick comparison of similar products. Please refer to the catalog page number referenced for complete product information and specifications.

SINGLE PRESSURE

Pressure Switches

						
SERIES	APS/AVS	A6	AP	A2	MVS	CXA
Set Point Range	28" Hg VAC to 500 psig (711 mm Hg VAC to 34.5 bar)	.5 to 150 psig (.03 to 10.3 bar)	10 in w.c. VAC to 125 psig (2.5 kPa VAC to 8.6 bar)	5 to 150 psig (.34 to 10 bar)	3 to 330 in w.c. VAC (8 to 822 mbar VAC)	15 to 150 psig (1.0 to 10.3 bar)
Service	Compatible liquids or gases	Compatible liquids or gases	Compatible liquids or gases	Compatible liquids or gases	Compatible liquids or gases	Compatible liquids or gases
Wetted Materials	17-4 PH SS and 303 SS	Polyimide with brass or 304 SS	Steel and Buna-N 04 316 SS and Teflon®	Kapton® and brass	Polycarbonate and polyurethane	Silicone, steel, and SS
Temperature Limits	-65 to 225°F (-54 to 107°C)	-40 to 248°F (-40 to 120°C)	-30 to 150°F (-35 to 66°C)	-40 to 250°F (-40 to 121°C)	40 to 150°F (4 to 66°C)	140°F (60°C)
Pressure Limits	750 psig (51 bar)	500 psig (34 bar)	160 psig (11 bar)	500 psig (34 bar)	330 in w.c. (822 mbar)	204 psig (14.1 bar)
Power Requirement	None	None	None	None	None	None
Repeatability	Consult factory	±10%	Consult factory	5%	20%	±5 psig (.3 bar)
Adjustable Deadband	No	No	No	No	No	Yes
Set Point Indication	Yes	No	Yes	No	No	No
Enclosure Rating	GP	GP or WP	GP, WP, or EXP	GP or submersible	GP	GP
Switch Type	SPDT	(1) SPST NO and (1) SPST NC	SPDT or DPDT	SPST	SPDT	SPST NO or NC
Multiple Stages	No	No	No	No	No	No
Process Connection	1/8" mail NPT	1/4" male NPT	1/4" female NPT	1/8" male NPT	Consult factory	1/4" female NPT

Teflon® is a registered trademark of E. I. Dupont De Nemours and Company

These Selection Guides are for quick comparison of similar products. Please refer to the catalog page number referenced for complete product information and specifications.



HIGH SINGLE PRESSURE - NON-INDICATING

Pressure Transmitters and Transducers

					
SERIES	681*	638R	682	672*	673*
Ranges	1 to 100 psi	75 to 667 psia (5.2 to 46 bar(a))	25 to 10,000 psi	10 to 400 in w.c.	Compound, 1 to 1000 psi
Accuracy	±0.20% FS	±1.2% FS	±0.13% FS	±0.25% FS	±0.25% FS
Wetted Materials	316L SS	Brass, aluminum, or 316 SS	17-4 PH SS	318 Duplex SS, Ceramic, fluoroelastomer	17-4 PH SS
Comp. Temp. Limits	20 to 180°F (-7 to 80°C)	-40 to 275°F (-40 to 135°C)	-4 to 176°F (-20 to 80°C)	-5 to 140°F (-20 to 60°C)	4 to 212°F (-20 to 100°C)
Oper. Temp. Limits	-40 to 260°F (-40 to 125°C)	-40 to 275°F (-40 to 135°C)	-40 to 260°F (-40 to 125°C)	-40 to 212°F (-40 to 100°C)	-40 to 260°F (-40 to 125°C)
Output Signal	4-20 mA	0.5-4.5 VDC ratiometric	4-20 mA	4-20 mA or 0-5 VDC	4-20 mA
Elec. Connection	15 ft (4.5 m) multi-conduit cable	Packard connection	2 ft (61 cm) multi-conductor cable	Large DIN 43650 connector with mating plug	2 ft (61 cm) multi-conductor cable
Process Connection	1-1/2" or 2" sanitary clamp	7/16" 20 UNF (female) or 1/4" NPT (female)	1/4" male or female NPT or BSPT	1/4"-18 male NPT	1/4" male NPT
Enclosure Rating	NEMA 4X (IP66)	IP67	NEMA 4X (IP66)	NEMA 4X (IP66)	NEMA 4X (IP66)

*CALIBRATION SERVICES AVAILABLE

These Selection Guides are for quick comparison of similar products. Please refer to the catalog page number referenced for complete product information and specifications.

HIGH SINGLE PRESSURE - NON-INDICATING

Pressure Transmitters and Transducers

SERIES	FDT*	626/628-GH*	636*	IS626*
Ranges	100 to 10,000 psi (7 to 690 bar)	Up to 300 psia, 8000 psig, 16 bar abs, 550 bar	15 to 300 psi (1 to 20 bar)	15 to 8000 psig (1 to 550 bar); 15 to 30 psia (1 to 3 bara)
Accuracy	±0.5% FS	626: ±0.25% FS; 628: ±1% FS	±0.30% FS	±0.25% FS; 0.5% FS for absolute ranges
Wetted Materials	316 and 15-5 SS	316, 316L SS	316L SS	316 and 316L SS
Comp. Temp. Limits	0 to 170°F (-18 to 77°C)	0 to 175°F (0 to 79°C)	-20 to 180°F (-29 to 82°C)	0 to 176°F (-18 to 80°C)
Oper. Temp. Limits	-40 to 200°F (-40 to 93°C)	0 to 200°F (0 to 94°C)	-40 to 212°F (-40 to 100°C)	0 to 176°F (-18 to 80°C)
Output Signal	4-20 mA or 0-5 VDC	4-20 mA	4-20 mA or 1-5 VDC	4-20 mA
Elec. Connection	4-pin	Cable, DIN connector, or 4-pin M12	2 ft (61 cm) cable, 3/4" female NPT conduit	3' cable or 4-pin M-12 connector
Process Connection	7/16-20 UNF male flush diaphragm; 1/4" male NPT	1/4" male or female NPT or BSPT	1/2" female NPT	1/4" male or female NPT or BSPT
Enclosure Rating	NEMA 4X (IP66)	NEMA 4X (IP66)	NEMA 4X (IP66)	NEMA 4X (IP66)

*CALIBRATION SERVICES AVAILABLE

These Selection Guides are for quick comparison of similar products. Please refer to the catalog page number referenced for complete product information and specifications.

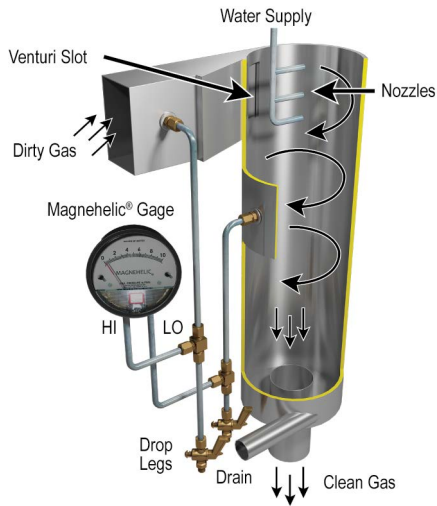

Differential pressure gage assists operator in adjusting venturi pressure drop in dust scrubber

This scrubber design removes unwanted dust or particulate matter from air or gas using an adjustable throat venturi. To adjust the pressure drop across the venturi, a jack-screw-actuated sliding vane varies the slot width. A permanently mounted Dwyer® Magnehelic® differential pressure gage indicates the venturi pressure drop while the operator adjusts to the desired or design setting. Where water may possibly enter the gage sensing lines, as in this application, drop legs with drain valves are needed to permit draining the lines at their lowest point. Good engineering practice dictates that the Magnehelic® gage always be mounted above the sensing tap when possible to prevent moisture accumulation in the lines and gage. At minimum, mount the gage above the lowest point in the sensing lines.

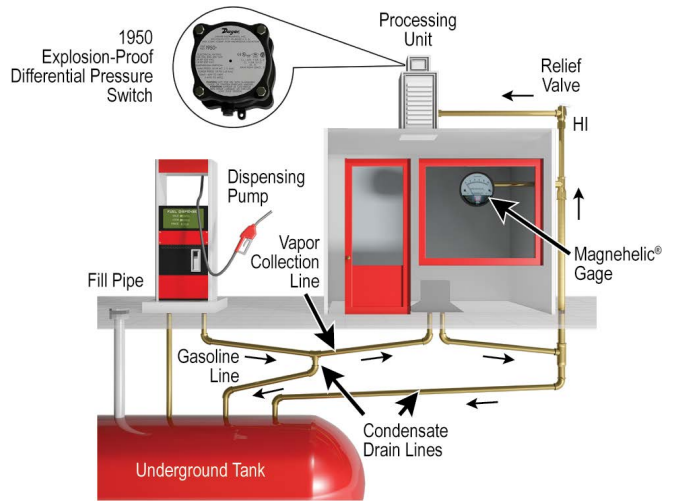

Gasoline vapor recovery system

Some area pollution control agencies require that 90% or more of gasoline vapor vented at service stations when fuel is dispensed must be prevented from venting to atmosphere. Using a dual hose dispenser, this vapor recovery system is a vacuum assist, vapor burnoff type. The blower creates a low vacuum at the nozzle, routing vapor from the automobile tank to underground storage tanks. As uncondensed vapor pressure reaches 2 in to 3 in w.c. pressure, a Dwyer® Series 1950 explosion-proof differential pressure switch activates a rooftop burnoff unit, which ignites excess vapor. The Magnehelic® differential pressure gage mounted on the station wall monitors tank pressure to verify system operation. The gage is calibrated in inches of gasoline, from +6 to -2. This allows the operator to determine the necessary level correction due to tank pressure prior to dipsticking the tanks through the fill pipe.

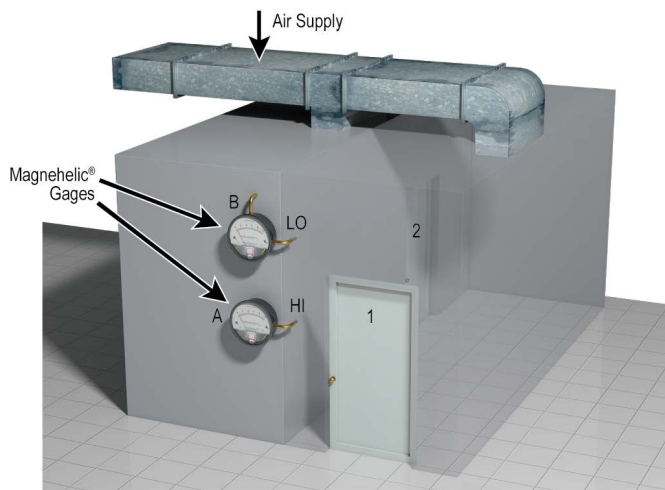

Dwyer® gages indicate pressurization of special rooms

A zero-center Dwyer® Magnehelic® differential pressure gage with a 0.25 in w.c. range either side of zero makes an effective monitor for proper operation of room pressurization systems. In the example, differential gage B has its high pressure port open to room 2 and its low pressure port to room 1; gage A has its high pressure port open to room 1 and its low pressure port open to the atmosphere. With the makeup air supply damper adjusted properly, room 2 will be a higher pressure than room 1 which is at higher than atmospheric pressure; both gages will read positive. Should the air supply to room 2 be obstructed, gage B will read negative. If the air supply fails entirely, both gages will read zero. For even better security, a Photohelic® switch/gage will provide automatic alarm or start-up of a backup system.



Filling scuba diver air tanks

The Dwyer® Series DPG differential pressure gage with oxygen cleaning and 5000 psi range is used in gas blending applications for filling scuba diver's air tanks. The DPG is the master mixing gage in this manifold apparatus. Two or three gases may be blended with the manifold to produce the appropriate blend of breathable gas depending on the diver and the depths they will reach. With the flow adjustment knobs and the 0.25% full-scale accuracy DPG, precise tank charging rates are maintained.

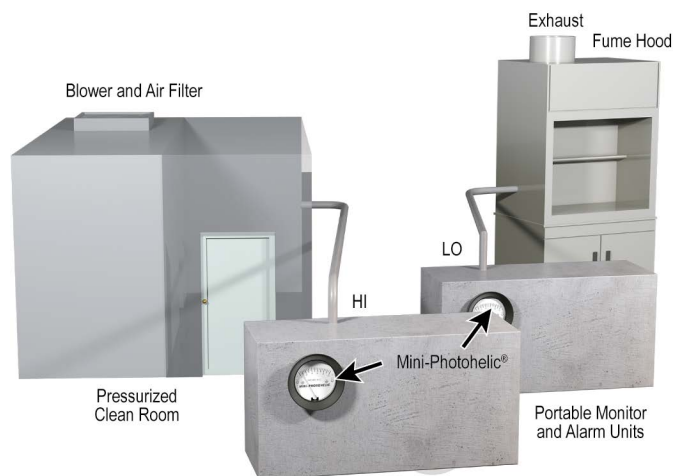

Compact switch/gage monitors pressure, actuates alarm

This portable pressure monitor alarm utilizes a Dwyer® Mini-Photohelic® differential pressure switch/gage to monitor either positive pressure, as in a clean room, or negative pressure, as in a fume or paint spray hood. It sounds an alarm, both audible and visual, when pressure exceeds either a preset high or low limit. The unit can be used temporarily to verify proper operation after initial installation, or it can be mounted permanently for continuous monitoring. In applications where a single fixed alarm pressure level is sufficient, a differential pressure switch can be used instead.

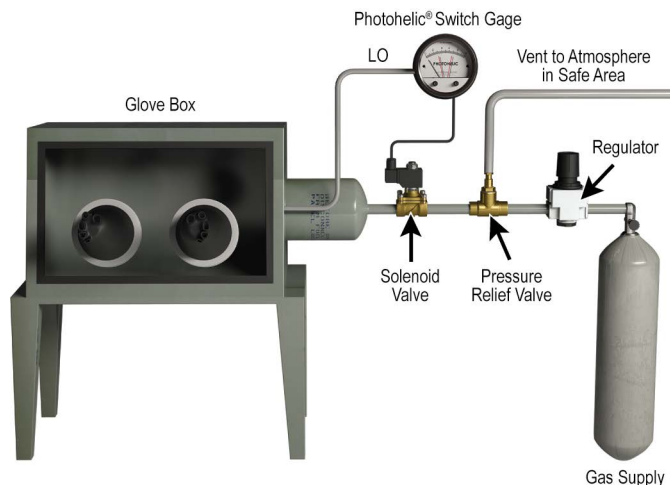

Zero-center switch/gage controls the inert atmosphere in glove box

A controlled inert atmosphere “glove-box” is used in the fields of physical chemistry and metallurgy for handling and welding special or hazardous materials. A Dwyer® Photohelic® differential pressure switch/gage serves as an automatic and readily adjustable pressure control for the helium, argon or nitrogen gas used in the system. The box is first evacuated, then pressurized with the required gas. Therefore, a zero-center Photohelic® switch/gage is used, permitting both pressure and vacuum to be read and controlled by a single gage. Use of the low pressure gage connection (rear chamber of gage) and a Buna-N diaphragm is suggested to minimize leaks from or to the atmosphere.

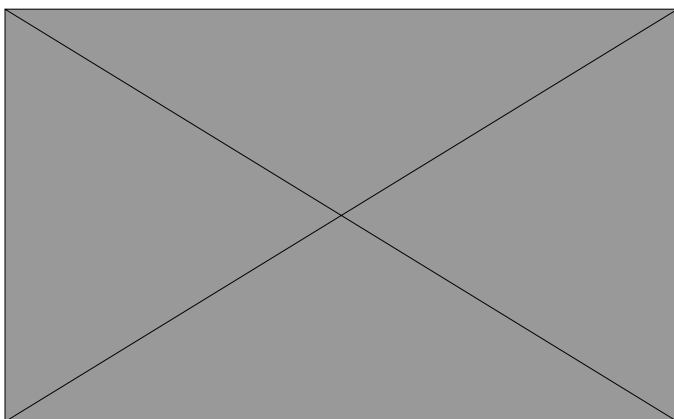

Mercoid® Series DA pressure switch maintains desired gas pressure in tank



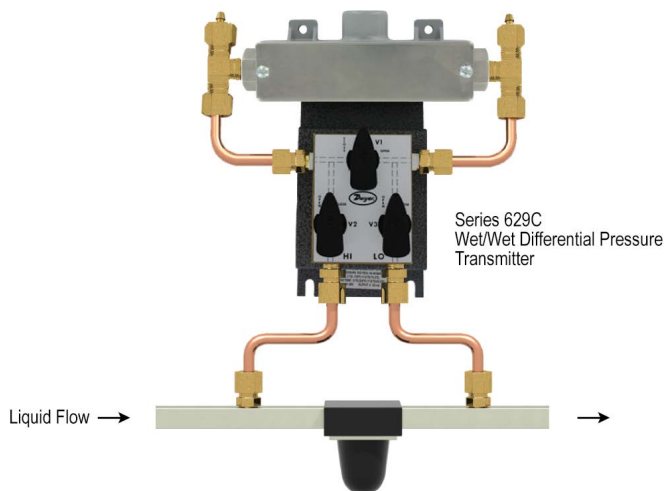

Demand for compressed gas varies in this gas line. Because of this, a Mercoid® Series DA adjustable deadband pressure switch is included to turn the compressor on at low pressure and off when the maximum pressure is reached.





Three-valve manifold simplifies installation of wet/wet differential pressure transmitter

When using differential pressure transmitters in fluid applications, it is essential to periodically make sure that there is no air in the system, as this can cause erroneous readings. Unfortunately, the necessary three-valve bleed system is often expensive and large, making installation difficult and bulky. For this reason, Dwyer Instruments, Inc. offers the 3V option on all 629C wet/wet differential pressure transmitters. This compact, lightweight, and economical bleed manifold is shipped factory-installed on the 629C, eliminating the hassle of constructing a custom apparatus. The 629C, when combined with the three-valve option, makes for an ideal setup to monitor hydraulic filter clogging or other fluid pressure sensing applications.

Dwyer**DIAL**
Thermometers

					
SERIES	BT	BTLRN	IT	BTO	RRT3
Range	0 to 1000°F	0 to 200°F	-40 to 550°F	0 to 550°F	-40 to 300°F
Dial Size	2", 3" or 5"	3"	9" liquid filled linear scale	3" or 5" with 4-20 mA temperature output	3-1/2" with set point and SPDT output
Stem Length	2.5", 4" or 6"	12" to 72"	2-1/2" or 5" thermowell	2-1/2", 4", 6", 9", or 12"	3-1/8" remote stem with 10.5' capillary
Process Connection	1/2" NPT; Back, lower, or adjustable mount	1/2" NPT; Back mount	3/4" NPT; Adjustable lower mount	1/2" NPT; Adjustable mount	1/2" NPT; Remote mount





LIMIT CONTROL
Digital Temperature Switches

			
SERIES	16L	TSF	TSF-DF
Number of Temperature Units	1	1	1
Temperature Input Type	Thermocouple, RTD, voltage, or current	Type J, K, or S thermocouple	Type J, K, or S thermocouple
Digital Input	No	Yes	Yes
Number of Relay Outputs	1 or 2	1	1
Relay Type	2 SPST, 1 SPDT	SPDT	SPST
Approvals	FM, UL	CE, FM, UL	CE, UL

These Selection Guides are for quick comparison of similar products. Please refer to the catalog page number referenced for complete product information and specifications.





PID LOOP CONTROLLERS

Temperature and Process Controllers

				
SERIES	16C, 8C, 4C	32B, 16B, 8B, 4B	16G, 8G, 4G	SCD
Number of Temperature Inputs	1	1	1	1 to 8
Temperature Input Type	Thermocouple or RTD	Thermocouple, RTD, current, or voltage	Thermocouple, RTD, current, or voltage	Thermocouple, RTD, current, or voltage
DIN Sizes	1/16, 1/8, 1/4	1/32, 1/16, 1/8, 1/4	1/16, 1/8, 1/4	DIN rail mount
Number of Outputs	1	2	2	2 to 16
Output Type	SPDT mechanical relay 14 VDC pulse voltage 4-20 mA current	SPDT mechanical relay 14 VDC pulse voltage 4-20 mA current 0-10 VDC voltage	SPDT mechanical relay 14 VDC pulse voltage 4-20 mA current 0-10 VDC voltage	SPDT mechanical relay 14 VDC pulse voltage 4-20 mA current 0-10 VDC voltage
Approvals	CE, UL	CE, UL	CE, UL	CE, UL

HEATING AND COOLING/REFRIGERATION CONTROL

Digital Temperature Switches

					
SERIES	TCS	TST & TS2	TSXT	TSS2	TSW
Number of Temperature Units	1	1	3	2	1 or 2
Temperature Input Type	Type J, K, or S thermocouple	TST: PTC or NTC thermistor; TS2: PTC	PTC or NTC thermistor	PTC or NTC thermistor	PTC or NTC thermistor
Digital Input	No	No	Yes	No	No
Number of Relay Outputs	1	2	1, 2, or 3	2	1 or 2
Relay Type	SPDT	SPDT	1 output models: SPDT 2 and 3 output models: SPST	SPDT	SPDT
Approvals	CE, UL	CE, cURus	CE, cURus	CE, cURus	CE, cURus



Environmental chamber control simplified with digital zone control

Environmental chambers have traditionally used separate controls to handle the temperature and relative humidity control tasks. The Love Controls® 32DZ dual zone control controls both parameters in a single small format (1/32 DIN) control to handle both zones, simplifying wiring and reducing panel costs. The 32DZ can switch small resistive loads directly or, when used with Dwyer® Series 62 solid state relays (not shown), can switch larger loads.

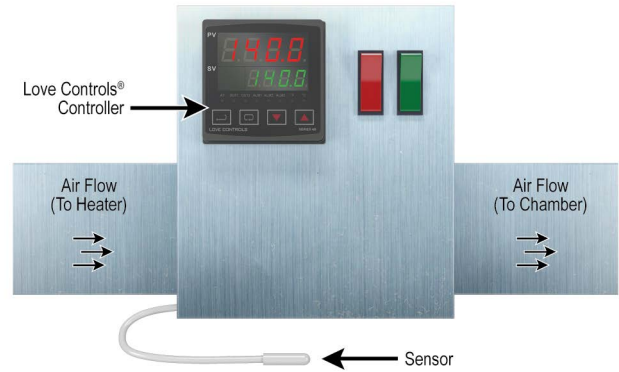

Dwyer® controllers used within heater controllers

In bioscience laboratories, the preferred methods of temperature control for experiments are heated water baths. There are experiments where water cannot be used, so the next feasible option is to send temperature controlled air to the experiment site. In order to use temperature controlled air, an air heater is needed. Within this product, a Love Controls® temperature controller is used for accurate and responsive temperature control. The Love Controls® controller can adapt to a different environment through different operating modes such as SELF-TUNE or manual PID adjustments, or preset PID responses.

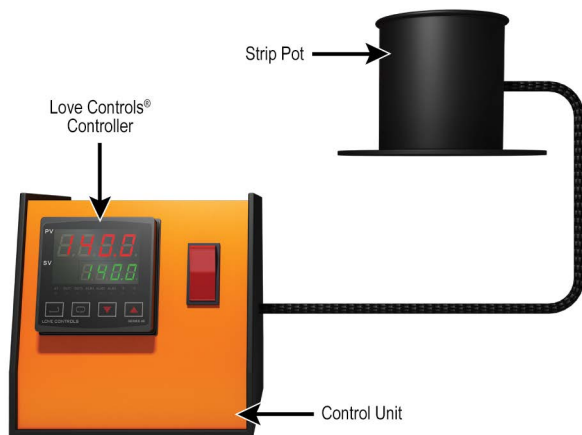

Love Controls® controllers involved in insulation removal

For most wires, removing the insulation is easy, but for magnetic and enamel wires, removing the insulation is very difficult. One way to easily remove the insulation of the magnetic or enamel wire is to dip them in a solution of molten fused salts. The salts are heated to a temperature high enough to melt the salts into a liquid, but not deteriorate them. This process uses a Love Controls® feedback temperature controller. The Love Controls® controller allows the operator to input a desired temperature and maintain that temperature accurately. The Love Controls® controller will also retain the input temperature after the power is disconnected.



Series TSX3 Digital Temperature Switches regulate temperature in refrigerated and display cases

When storing food or other perishables in chillers or display cases, temperature must be carefully regulated to ensure the products remain fresh. If the storage area rises above the critical preservation temperature, products can have their shelf life dramatically shortened or be spoiled altogether. A Dwyer® Series TSX3 digital temperature switch will prevent these scenarios by monitoring temperature and activating refrigeration and defrost cycles to ensure the storage temperature stays within safe limits.

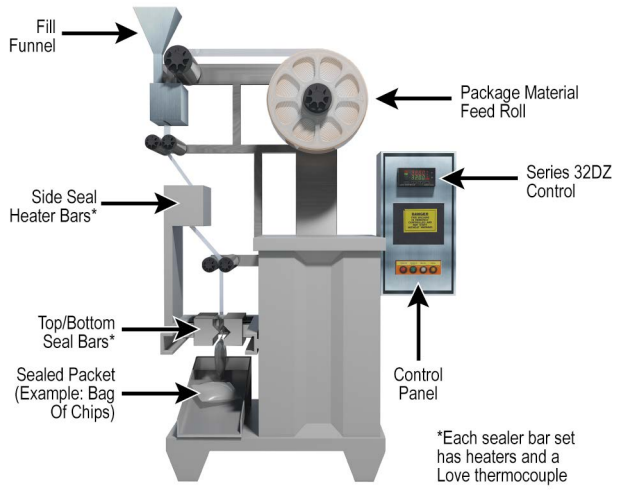

Form, fill and seal machine control simplified with dual zone control

Form, fill and seal machines traditionally have used separate controls to handle the temperature control requirement for the side and top/bottom seal bars. The Love Controls® 32DZ allows for a single small format (1/32 DIN) control to handle both zones, simplifying wiring and reducing panel costs. The 32DZ can switch small resistive loads directly or, when used with the Love® 62 Series solid state relays (not shown), can switch larger loads.



Love Controls® controllers used in the packaging of condiments

Packaging of condiments require the sealing bars to be heated to a temperature hot enough to seal the packages, but not destroy the packaging material. The heat on the sealing bars needs to be controlled to ensure the heat does not become excessive. Love Controls® controllers are used in this process to accurately control the heat on the sealing bars. The sensors from the Love Controls® controllers are placed on the sealing bars to ensure accurate temperature readings. Should the heat become excessive, an alarm light on the controller notifies the operator of the impending conditions.



Resin transfer molding

Accurate control of temperature and epoxy resin flow is important during resin transfer molding. For the epoxy resin to have an even and thorough flow, the resin must be at a temperature high enough to allow it to flow, yet not burn the resin. With the help of a Love Controls® controller, the temperature of the resin is accurately controlled under different conditions through the different PID operating modes. Another Love Controls® controller, with a flow transducer, is used in this process to control the flow of the epoxy resin. The Love Controls® controller provides information on the temperature and flow rate to the computer through an RS-485 serial communication option.

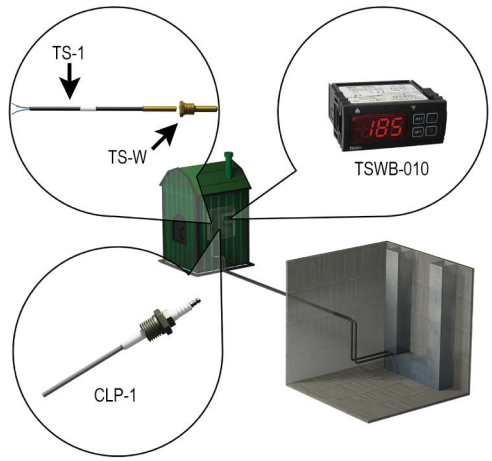

Controlling water temperature in outdoor wood furnace

The Series TSWB is the ideal control for monitoring water temperature and water level in outdoor wood furnaces. The Series TSWB controls the damper and/or the fan that provides oxygen to the flame in the fire box. Usually an external light will also be controlled by the Series TSWB to inform the user that the furnace is out of wood or that the water level is low. The TSWB accepts thermistor inputs for temperature and conductivity probe, Dwyer CLP-1, inputs for monitoring water level.

Dwyer





DIGITAL
Manometers

SERIES	477AV*	475*	476A*	478A*
Range	1 in w.c. to 150 psi (.25 kPa to 10.34 bar)	1 in w.c. to 150 psi (.25 kPa to 10.34 bar)	±20 in w.c. (±5 kPa)	±4 in w.c.; ±60 in w.c. (±1 kPa; ±15 kPa)
Service	Air and compatible gases	Air and compatible combustible gases	Air and compatible gases	Air and compatible gases
Wetted Materials	Consult factory	Consult factory	Consult factory	Consult factory
Accuracy	±0.5% FS	±0.5% FS	±1.0% FS	±0.5% FS
Pressure Limits	5 psig (1 to 10 in w.c.); 10 psig (20 to 40 in w.c.); 30 psig (200 in w.c. to 10 psi); 60 psig (20 to 30 psi); 150 psig (100 psi); 200 psig (150 psi)	5 psig (1 to 10 in w.c.); 10 psig (20 to 40 in w.c.); 30 psig (200 in w.c. to 10 psi); 60 psig (20 to 30 psi); 150 psig (100 psi); 200 psig (150 psi)	5 psig (.34 bar)	5 psig (.34 bar)
Temperature Limits	0 to 140°F (-17.8 to 60°C)	0 to 140°F (-17.8 to 60°C)	0 to 140°F (-17.8 to 60°C)	0 to 140°F (-17.8 to 60°C)
Comp. Temp. Limits	32 to 104°F (0 to 40°C)	32 to 104°F (0 to 40°C)	32 to 104°F (0 to 40°C)	32 to 104°F (0 to 40°C)
Housing Protection	Rugged aluminum housing	Rugged aluminum housing	Rugged aluminum housing	Rugged aluminum housing
Display	4-digit backlit LCD	4-digit LCD	4-digit LCD	4-digit LCD
Memory	40 readings	N/A	N/A	N/A
Process Connection	(2) Barbed connections for use with 1/8" or 3/16" ID tubing (Compression fittings for -7, -8 ranges)	(2) Barbed connections for use with 1/8" or 3/16" ID tubing (Compression fittings for -7, -8 ranges)	Barbed connection for use with 3/16" or 1/4" ID tubing	(2) Barbed connection for use with 3/16" or 1/4" ID tubing
Approvals	CE	CE, FM	CE	CE

***CALIBRATION SERVICES AVAILABLE**

These Selection Guides are for quick comparison of similar products. Please refer to the catalog page number referenced for complete product information and specifications.

DIGITAL Manometers

				
SERIES	477B*	HM35*	HM28*	490A*
Range	20 in w.c. to 100 psi (4.982 to 689.5 kPa)	10 in w.c. to 1305 psi (2.5 to 9000 kPa)	10 in w.c. to 245 psi (2.5 to 1700 kPa)	15 to 200 psi (1 to 13.8 bar)
Service	Air and compatible gases	Air and compatible gases	Air and compatible gases	Compatible gases and liquids
Wetted Materials	Consult factory	18/8 SS	18/8 SS	316L SS; With 3-way valve: Buna-N, silicone grease, PTFE, brass 360, copper, reinforced acetal copolymer
Accuracy	±0.1% FS	(±0.2% FS, ±0.1% FS, or ±0.05% FS) ±1 digit	(±0.2% FS, ±0.1% FS, or ±0.05% FS) ±1 digit	±0.5% FS
Pressure Limits	3 psig (20 to 40 in w.c.); 15 psig (200 in w.c.); 30 psig (10 psi); 60 psig (30 psi); 100 psig (50 psi); 200 psig (100 psi)	N/A	N/A	30 psig (15 psi); 60 psig (30 psi); 100 psig (50 psi); 200 psig (100 psi); 400 psig (200 psi); 1000 psig (500 psi)
Temperature Limits	0 to 140°F (-17.8 to 60°C)	32 to 122°F (0 to 50°C)	23 to 122°F (-5 to 50°C)	32 to 140°F (0 to 60°C)
Comp. Temp. Limits	N/A	N/A	N/A	N/A
Housing Protection	Rugged aluminum housing	IP54 (NEMA 3)	IP54 (NEMA 3)	Rugged aluminum housing
Display	4-digit backlit LCD	Graphical backlit LCD, 128 x 64 points	2 line, 16 character, dot matrix LCD, with switchable display sizes	4-digit backlit LCD
Memory	40 readings	10,742 readings	10,742 readings	Up to 40 readings
Process Connection	(2) Barbed connections for use with 1/8" or 3/16" ID tubing (Compres- sion fittings for -6, -7 ranges)	Hose 4/6 mm or 1/8" NPT	Hose 4/6 mm or 1/8" NPT	(2) 1/8" female NPT
Approvals	CE	N/A	N/A	CE

***CALIBRATION SERVICES AVAILABLE**

These Selection Guides are for quick comparison of similar products. Please refer to the catalog page number referenced for complete product information and specifications.







Dwyer**THERMO**
Anemometers

SERIES	471B*	473B*
Air Velocity Range	0 to 6000 FPM (0 to 30 m/s)	40 to 5000 FPM (0.2 to 25 m/s)
Air Velocity Accuracy	±3% FS	±1.5% of reading ±20 FPM
Temperature Range	-40 to 212°F (-40 to 100°C)	-20 to 212°F (-29 to 100°C)
Temperature Accuracy	±0.5°F (±0.28°C)	±0.54°F (±0.3°C)
Humidity Range	N/A	0 to 100% RH
Humidity Accuracy	N/A	±2% RH
Air Volume Range	19,999 in selected flow units	19,999 in selected flow units
Wet Bulb Range	N/A	N/A
Meter Temperature Range	Process Air Velocity: -20 to 212°F (-29 to 100°C); Process Temperature: -40 to 212°F (-40 to 100°C); Ambient: 5 to 125°F (-15 to 51°C)	Process: -20 to 212°F (-29 to 100°C); Ambient: 5 to 125°F (-15 to 51°C)
Meter Humidity Limits	N/A	N/A
Display	4.5-digit backlit LCD	4.5-digit backlit LCD
Approvals	CE	N/A

***CALIBRATION SERVICES AVAILABLE**

These Selection Guides are for quick comparison of similar products. Please refer to the catalog page number referenced for complete product information and specifications.

CALIBRATION Pumps

							
SERIES	HP	CHP	A-396A	PCHP	HCHP	LPCP	BCHP
Output Range	-27" Hg to 45 psig (-0.91 to 3 bar)	-28.8" Hg to 100 psi (-0.975 to 3.4 bar)	<1 in w.c. to 72 psig (5 bar)	-28" Hg to 600 psi (-0.945 to 40 bar)	0 to 10,000 psi (0 to 700 bar)	-5.8 psi to 5.8 psi (-0.4 to 0.4 bar)	-28" Hg to 870 psi (-0.95 to 60 bar)
Process Connection	1/4" female NPT	1/8" female NPT	Barbed fitting or 1/8" female NPT	1/4" female NPT/BSPT	1/4" female NPT/BSPT	M20x1.5 or 1/4" female NPT	1/4" female BSPT (NPT available)
Gage Connection	1/4" female NPT	1/8" female NPT	N/A	1/8" female NPT/BSPT	1/4" female NPT/BSPT	M20x1.5 or 1/4" female NPT	1/2" female BSPT
Materials	N/A	Acetal plastic and anodized aluminum	N/A	SS fittings, anodized aluminum housing, plastic/rubber handles, and nitrile O-rings	SS, polyurethane, anodized hard-coat aluminum, PTFE, and nitrile	Ram/adapters: 316 SS, Body: Steel/aluminum; Seals: Buna-N	Anodized aluminum, brass, and ABS

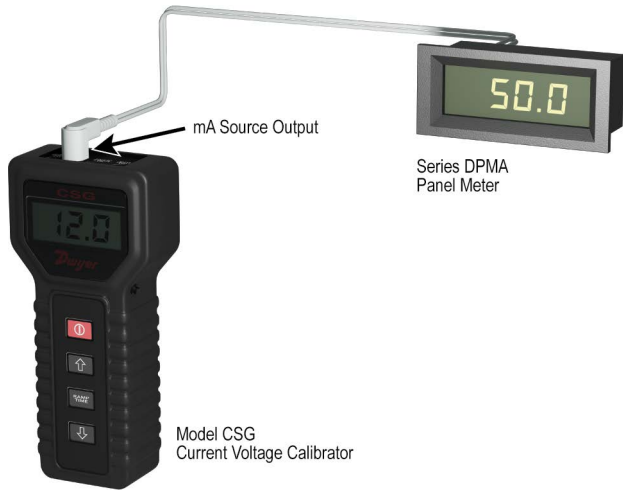

Current/voltage signal generator used to calibrate panel meters

The Model CSG digital signal generator is perfect for generating or simulating input signals to panel meters and process controllers. The signal generator is capable of sourcing up to 10 VDC or 20 mA in 1 VDC or 1 mA steps. The backlit digital display allows users to quickly compare the reading on the Model CSG to that of the panel meter or process controller. The signal from the Model CSG can be used to set up the upper and lower limits of the process range. It can also be used to ensure that set point and alarm functions are working properly on the panel meter or process controller.

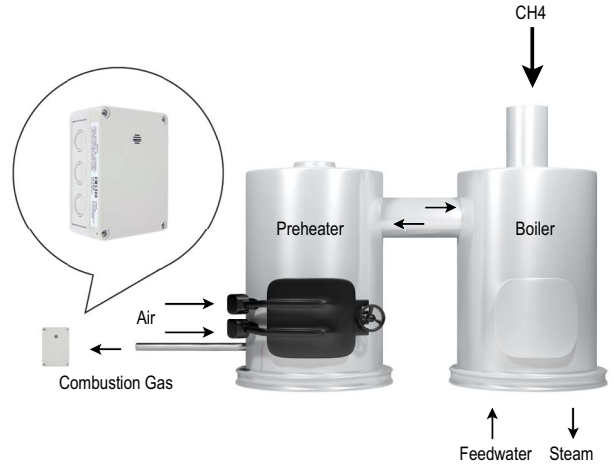

Carbon monoxide transmitter/switch maximizes boiler efficiency while monitoring harmful products of combustion

There are several critical factors in attaining efficient combustion for boilers and other combustors. Monitoring the temperature of combustion and minimizing the amount of excess air in the system are undoubtedly essential steps. A Dwyer® Model CMS300 measures harmful CO gas bi-products of the combustion cycle in a boiler system. The switch contact in the CMS300 can be used for a local alarm indication, in addition to sending an analog output to a building control system.

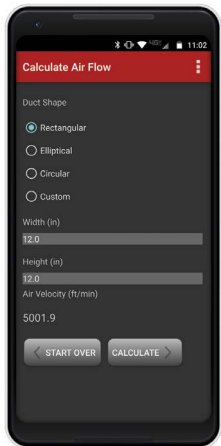

FREE DOWNLOAD!
Download our Air Velocity and Flow Calculator app today.



HVAC mobile application

For those customers in the HVAC or BAS industry, Dwyer offers the Air Velocity and Flow Calculator App available on the Google Play® store. One can easily convert velocity pressure to air velocity or air velocity to air volume. Converting velocity pressure to air volume is advantageous for effortlessly changing the pressure on your Magnehelic® differential pressure gage or manometer to velocity. Moreover, this calculator also includes air density factors from humidity levels. By utilizing the air velocity to air volume functionality, one can simplistically convert the air velocity to air flow rates from duct dimensions, with just the tap of a button.

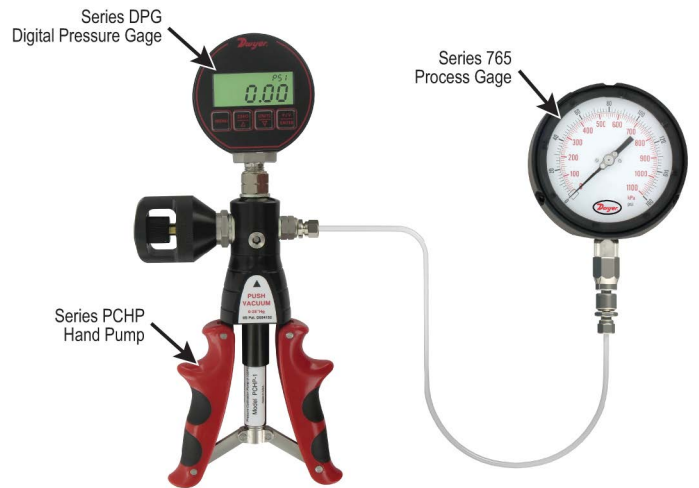

Field calibrate and certify pressure gages

Using the Series PCHP with a Series DPG-100, a technician can calibrate or certify process pressure gages up to 1% accurate. The Model PCHP-1 hand pump can easily supply pressures up to 600 PSI by squeezing the handle and adjusting the volume control valve. The pump has two connections to be connected with a test gage, such as the Dwyer® Series DPG-100, and a process gage, such as the Dwyer® Series 765.

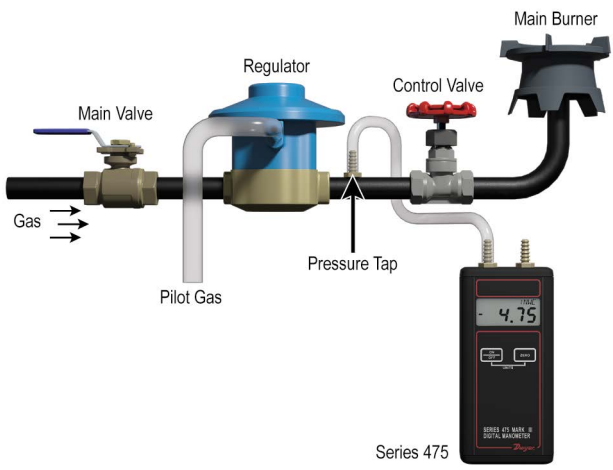

Digital manometers used to check gas pressure to a heating burner

Checking the gas pressure to a heating unit on the burner side of the regulator is a standard installation and service routine. The Dwyer® Series 475 handheld digital manometer is a low-cost, durable device that is easily transportable in a pocket or briefcase. Units are highly accurate with 0.5% full-scale accuracy. Some servicemen prefer our portable Dwyer® Magnehelic® differential pressure gage with dial type scale for field use.

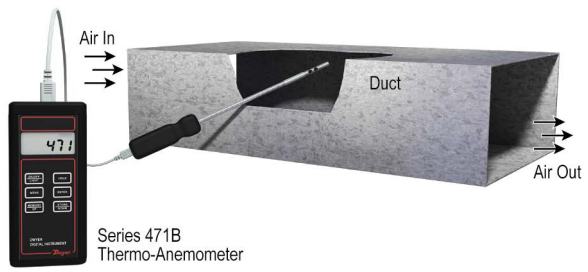

Determine air velocity and temperature levels in ducts or air supply grills

The Dwyer® Series 471B digital thermo-anemometer is the ideal portable product for determining air velocity and temperature levels in ducts or air supply grills. With a push of a button, FPM and Fahrenheit readings are converted to MPS and Celsius. Readings may be stored and retrieved which allows the user greater efficiency with HVAC balancing at various locations in a building.

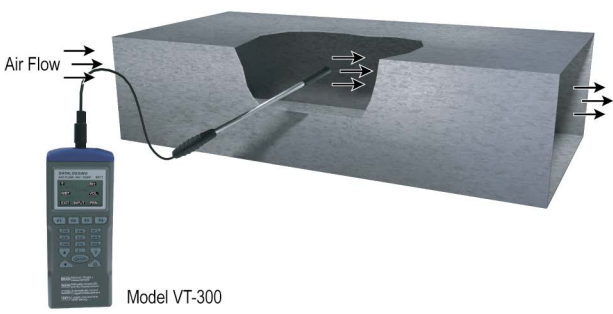

Handheld anemometer enables measuring duct flow measurements

Handheld anemometers are an excellent, portable tool for performing tests on HVAC system performance; however, large rotating vanes can prevent easy access to ducts. Dwyer introduces the VT-300 mini-vane thermo-anemometer to eliminate this problem. Additionally, simple keypad programming enables the user to view volumetric flow rates in CFM or CMM.









Quickly measure humidity and temperature levels in ambient air

The Dwyer® Model 485B-1 thermo-hygrometer is a simple, portable device for quickly measuring humidity and temperature levels in ambient air. The dew point and wet-bulb temperature readings are derived from relative humidity and temperature measurements. The Model 485B-1 is often used in agricultural applications where proper humidity and temperature levels are critical in plant or animal well being.





AIR VELOCITY

Transmitters

						
SERIES	AVUL	AVPT	AVLV	641*	641RM*	641B
Service	Clean air	Clean air	Clean air	Clean air	Clean air	Clean air
Range	1,000 to 4,000 FPM (5 to 20 MPS)	1,000 to 4,000 FPM (5 to 20 m/s)	100 to 400 FPM (0.5 to 2 m/s)	250 to 15000 FPM (1.25 to 75 MPS)	250 to 2000 FPM (1.25 to 10 MPS)	250 to 2000 FPM (1.25 to 10 MPS)
Accuracy	±3 or 5% of reading	±3 or 5% of reading	±1 or 2% of reading	±3 to 4% FS	±3 to 4% FS	±5 to 6% FS
Mounting	Duct mount	Duct mount	Duct mount	Duct mount	Remote mount	Duct mount
Probe Length	7-41/64"	6" or 12"	7-41/64"	6 to 36" (152 to 915 mm)	6 to 36" (152 to 915 mm)	4-1/4" (108 mm)
Output	4-20 mA, 0-5 VDC, or 0-10 VDC selectable	0-5 VDC or 0-10 VDC	4-20mA, 0-5 VDC, or 0-10 VDC selectable	4-20 mA	4-20 mA	4-20 mA
Display	Optional LCD	None	Optional LCD	Optional LED	Optional LED	Optional LED
Process Temperature Limits	32 to 122°F (0 to 50°C)	-4 to 140°F (-20 to 60°C)	-32 to 122°F (0 to 50°C)	-40 to 212°F (-40 to 100°C)	-40 to 212°F (-40 to 100°C)	-40 to 176°F (-40 to 80°C)

HUMIDITY AND HUMIDITY/TEMPERATURE

Transmitters

					
SERIES	RHP-E/N*	RHPLC	RHP*	RHP with Shield	WHT
Service	Room	Room	Duct or outdoor	Outdoor	Room or outdoor
Accuracy	±2, 3, or 5% FS	±2 or 3% FS	±2, 3, or 5% FS	±2, 3, or 5% FS	±3% FS
RH Output	4-20 mA, 0-5 VDC, 0-10 VDC	4-20mA, 0-5 VDC, 0-10 VDC	4-20 mA, 0-5 VDC, 0-10 VDC	4-20 mA, 0-5 VDC, 0-10 VDC	4-20 mA, 0-5 VDC, 0-10 VDC
Temperature Output Options	None, passive sensor, 4-20 mA, 0-5 VDC, 0-10 VDC	None, passive sensor, 4-20mA, 0-5 VDC, 0-10 VDC	None, passive sensor, 4-20 mA, 0-5 VDC, 0-10 VDC	None, passive sensor, 4-20 mA, 0-5 VDC, 0-10 VDC	None, passive sensor, 4-20 mA, 0-5 VDC, 0-10 VDC
Display	Optional LCD	None	None	None	None

*CALIBRATION SERVICES AVAILABLE

These Selection Guides are for quick comparison of similar products. Please refer to the catalog page number referenced for complete product information and specifications.

CARBON MONOXIDE Sensors



SERIES	GSTA	GSTC	CMT200	CMS300
Service	Carbon monoxide or nitrogen dioxide	Carbon monoxide or nitrogen dioxide	Carbon monoxide	Carbon monoxide
Range	0 to 500 PPM CO or 0 to 10 PPM NO ₂	0 to 500 PPM CO or 0 to 10 PPM NO ₂	0 to 200 PPM CO	0 to 300 PPM CO
Housing	Space or duct	Space or duct	Space	Space
Output	4-20 mA, 0-5 VDC, 1-5 VDC, 0-10 VDC, 2-10 VDC	BACnet MS/TP, Modbus® RTU, Modbus® ASCII	4-20 mA, 2-10 VDC	4-20 mA, 2-10 VDC
Relay	None	N/A	N/A	(1) SPDT
Display	Optional LCD	Optional LCD	N/A	N/A

HUMIDITY AND HUMIDITY/TEMPERATURE Transmitters



SERIES	RH-R	657*	657C*	HHT
Service	Duct or process	Duct	Duct	Room or outdoor
Accuracy	±2% FS	±2% FS	±2% FS	±2% FS
RH Output	4-20 mA	4-20 mA	4-20 mA	4-20 mA
Temperature Output	None, 4-20 mA	4-20 mA	4-20 mA	None, 4-20 mA
Options				
Display	None	None	None	Optional LCD

Modbus® is a registered trademark of Schneider Automation, Inc.

***CALIBRATION SERVICES AVAILABLE**

These Selection Guides are for quick comparison of similar products. Please refer to the catalog page number referenced for complete product information and specifications.

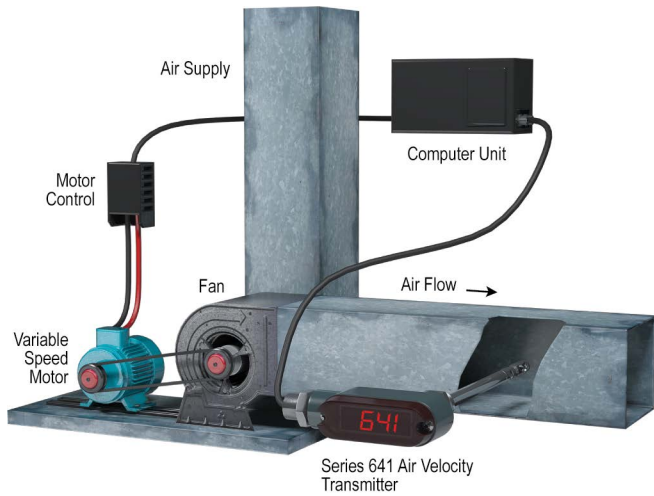

Dwyer® transmitter signals precise air velocity adjustments to computer-controlled variable-speed fan motor

In variable air volume (VAV) HVAC systems, a computerized control provides precise adjustment of air volume to meet changing system needs with maximum energy efficiency. The Dwyer® Series 641 has an optional LED display for local indication of air flow. The LED display provides a quick, visual acknowledgment of proper system performance. The computer reacts to any change in velocity by signaling the motor control to increase or decrease fan speed to maintain the required velocity. The computer, taking inputs from other ambient condition sensors, will establish a new required air velocity and signal an appropriate adjustment in fan speed.

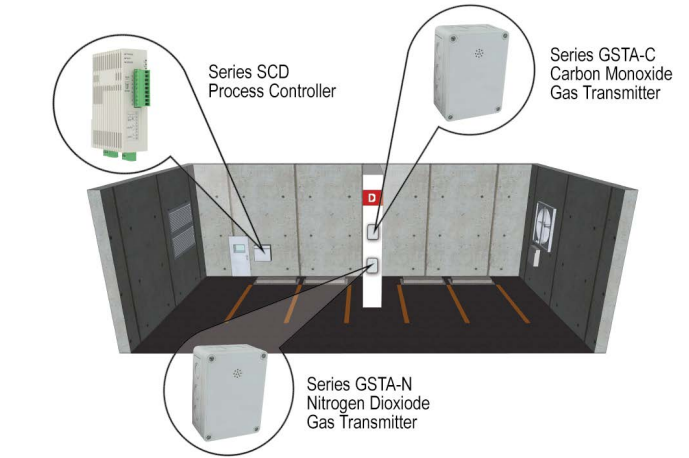

Automate your garage ventilation

Carbon monoxide and Nitrogen Dioxide are by-products released in the exhaust from gasoline and diesel powered vehicles. These gases can build up in parking garages and loading dock areas where vehicles are concentrated, creating a potentially harmful environment. Ventilation is required to purge these gasses, but running fans non-stop increases building operating costs. The Dwyer® Series GSTA and GSTC can help to offer a more efficient solution to garage ventilation by transmitting CO or NO₂ concentrations via an analog output signal or digital BACnet/Modbus® communication. This signal is sent to the Building Management System and the ventilation processes can then be automated to run only when the gases are present in dangerous concentrations. For stand-alone systems, the analog signal can be sent to a Series SCD process controller to provide a closed loop control system running the ventilation fans. Using the Dwyer® Series GSTA or GSTC transmitter, ventilation will occur only when needed, reducing the cost of maintaining air quality standards.

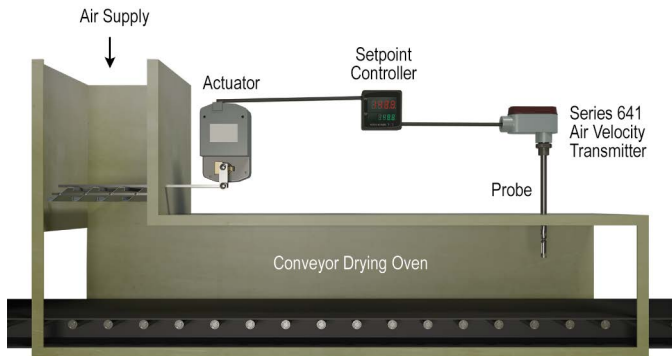

Air velocity transmitter controls drying oven air flow

The flow of heated air is held to a constant predetermined velocity in this carefully controlled low temperature process drying oven. The constant temperature air supply is modulated by a set of inlet louvers operated by a servo-driven actuator. A Dwyer® Series 641 air velocity transmitter has an optional LED display for local indication of air flow. The LED display provides a quick, visual acknowledgment of proper system performance. The controller compares the Series 641's signal to the set point in the controller and continuously signals appropriate louver adjustments to the actuator.



Eliminate the need for Pitot tubes, orifice plates, differential pressure sensors and temperature sensors with a Series AVUL

Installing air velocity measurement systems can be a burdensome process – specifying Pitot tubes, static pressure tips, orifice plates, differential pressure transmitters, etc. Dwyer offers the Series AVUL air velocity transmitter to consolidate these components into one convenient instrument. The Series AVUL can be easily installed into the duct or air stream to accurately measure air flow while providing local indication as well as linear analog output. Microprocessor-based technology ensures accurate, repeatable results. The Series AVUL combines these features for simple, reliable airflow measurement without the problems associated with complex, traditional systems.

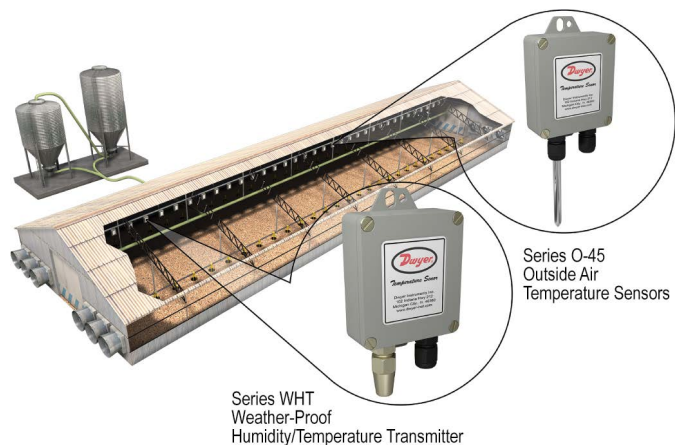

Temperature and humidity measurements used to optimize the growth of hogs and poultry

The Dwyer® Series WHT humidity transmitter and Series O-4 temperature sensors are used to control the environmental conditions on hog and poultry farms. The amount the animals eat is linked to how comfortable the environmental conditions are. Thus the temperature, humidity, amount of light and other ambient conditions are tightly controlled to insure optimal animal growth.

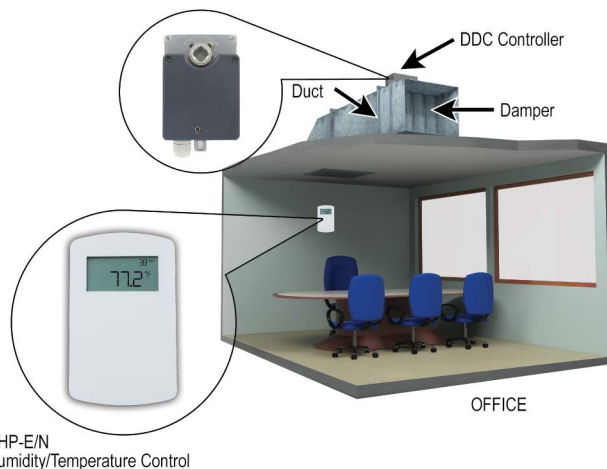

Accurately measure and control the humidity and temperature in office buildings

The Dwyer® Series RHP-E/N wall mount humidity and temperature transmitter can be combined with a DDC controller and a damper to provide comfortable working conditions in an office building. The amount of air flow entering the room is varied based on the temperature and humidity readings of the Series RHP-E/N. The compact size and mounting configuration allow this transmitter to be discretely mounted in any room.

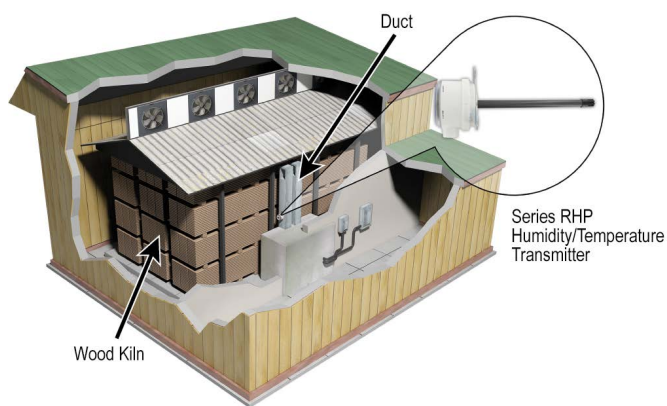

Greatly reduce the time it takes to dry wood

The Dwyer® Series RHP monitors the humidity and temperature in the return air ducts in wood dehumidification rooms. Large fans are used to circulate air across the room. As dry conditioned air moves across the wood, it absorbs moisture from the wood. The humidity level of the air in the return air duct is representative of how much moisture is in the wood. When the humidity in the duct declines, it signifies that less dry conditioned air is needed to be supplied to the room.









Demand control ventilation

Since the number of people in a conference room or classroom varies throughout the day, the amount of conditioned air needed to properly ventilate the room varies as well. As the number of people in a room increase, the concentration of carbon dioxide in the room will also increase. The Dwyer® Series CDT, CDTR, CDTV, and CDTA carbon dioxide transmitters measures the amount of carbon dioxide that is emitted so that the VAV control system can supply enough fresh air into the space to return the concentration of carbon dioxide in the room to normal levels.

GENERAL PURPOSE PANEL MOUNT

Flowmeters

						
SERIES	RMA*	RMB*	RMC*	VFA*	VFB*	VFC*
Ranges	0.05 to 200 SCFH air (5 to 2500 cc/m air); 1 to 50 GPH water (5 to 300 cc/m water)	0.5 to 600 SCFH air (0.6 to 95 LPM air); 1 to 100 GPH water (0.06 to 6.2 LPM water)	5 to 1800 SCFH air (2.5 to 850 LPM air); 0.1 to 10 GPM water (0.05 to 5 LPM water)	0.1 to 200 SCFH air (0.06 to 100 LPM air); 0.6 to 40 GPH water (6 to 200 cc/m water)	0.3 to 200 SCFH air (0.2 to 40 LPM air); 0.5 GPH to 5 GPM water (0.002 to 20 LPM water)	2.5 to 100 SCFM air (60 to 2800 LPM air); 0.5 to 20 GPM water (2 to 75 LPM water)
Accuracy	±4% FS	±3% FS	±2% FS	±5% FS	±3% FS	±2% FS
Body Materials	Polycarbonate	Polycarbonate	Polycarbonate	Acrylic	Acrylic	Acrylic
Temperature Limits	130°F (54°C)	130°F (54°C)	130°F (54°C)	With valve: 120°F (48°C); Without valve: 100°F (38.6°C)	With valve: 120°F (48°C); Without valve: 100°F (38°C)	120°F (48°C)
Pressure Limits	100 psi (6.7 bar)	100 psi (6.7 bar)	100 psi (6.7 bar)	With valve: 100 psi (6.7 bar); Without valve: 150 psi (10 bar)	With valve: 100 psi (6.7 bar); Without valve: 150 psi (10 bar)	100 psi (6.7 bar)
Process Connection	1/8" female NPT back connections	1/4" female NPT back connections	1/2" female NPT back connections	1/8" female NPT back or end connections	1/8" female NPT back or end connections	1" female or male NPT or BSPT back or end connections
Scale Length	2" (51 mm)	5" (127 mm)	10" (254 mm)	2" (51 mm)	4" (102 mm)	5" (127 mm)
Metering Valve	Optional bottom or top mount brass or stainless steel valve	Optional bottom brass or stainless steel valve	Optional bottom brass or stainless steel valve	Optional bottom or top mount brass or stainless steel valve	Optional bottom brass or stainless steel valve	N/A

CORROSIVE MEDIA







Flowmeters

								
SERIES	VAT*	TVA*	VA1000*	VA1500*	VAT20000*	VA25000*	DR10000*	DR20000*
Ranges	1.19 to 79 GPH water (75 to 5000 ml/min water)	6.34 to 79.2 GPH water (400 to 5000 ml/min water)	0.104 to 89.2 SCFH air (49 to 42000 ml/m air) 0.009 to 19.97 GPH water (0.55 to 1260 ml/m water)	0.22 to 49 SCFH air (104 to 23100 ml/min air) 0.028 to 27 GPH water (1.8 to 522 ml/min water)	0.792 to 93.9 SCFH air (374 to 44300 ml/min air) 0.087 to 21.7 GPH water (5.5 to 1370 ml/m water)	0.104 to 18.39 SCFH air (49 to 8600 ml/m air) 0.01 to 3.32 GPH water (0.61 to 209 ml/min water)	0.24 to 100 SCFH air (0.13 to 50 LPM air) 0.02 to 24 GPH water (1.5 to 1500 cc/m water)	0.33 to 90 SCFH air (0.16 to 44 LPM air) 0.05 to 21 GPH water (3.2 to 1300 cc/m water)
Accuracy	±5% FS	±5% FS	±2% FS	±2% FS	±2% FS	±2% FS	±5% FS	±5% FS
Body Materials	PFA	PFA	Glass flow tube	Glass flow tube	Glass flow tube	Glass flow tube	Glass flow tube	Glass flow tube
Temperature Limits	250°F (121°C)	250°F (121°C)	250°F (121°C)	150°F (65°C)	250°F (121°C)	150°F (65°C)	250°F (121°C)	250°F (121°C)
Pressure Limits	100 psi (6.7 bar)	100 psi (6.7 bar)	200 psi (13.8 bar)	100 psi (6.7 bar)	200 psi (13.8 bar)	100 psi (6.7 bar)	250 psi (17 bar)	250 psi (17 bar)
Process Connection	1/4" or 3/8" female NPT back connections	1/4" or 3/8" female NPT back connections	1/8" female NPT back connections	1/8" female NPT back connections	1/8" female NPT back connections	1/8" female NPT back connections	1/8" female NPT back connections	1/8" female NPT back connections
Scale Length	5" (127 mm)	3" (75 mm)	2.5" (65 mm)	2.5" (65 mm)	6" (150 mm)	6" (150 mm)	2.5" (65 mm)	6" (150 mm)
Metering Valve	N/A	Optional 6-turn needle valve	6-turn needle valve; Optional 16-turn high precision valve	6-turn needle valve	6-turn needle valve; Optional 16-turn high precision valve	6-turn needle valve	Optional 6-turn needle valve	Optional 6-turn needle valve



*CALIBRATION SERVICES AVAILABLE

These Selection Guides are for quick comparison of similar products. Please refer to the catalog page number referenced for complete product information and specifications.

GENERAL PURPOSE IN-LINE Flowmeters

						
SERIES	LFMA*	LFMB*	LFMC*	LFMD*	LFME*	LFMF*
Ranges	0.1 to 5 GPM water (0.5 to 18 LPM water)	0.1 to 5 GPM water (0.5 to 18 LPM water)	0.25 to 8 GPM water (1 to 30 LPM water)	0.8 to 10 GPM water (3 to 40 LPM water)	1.2 to 25 GPM water (5 to 100 LPM water)	2.5 to 70 GPM water (10 to 250 LPM water)
Accuracy	±5% FS	±5% FS	±5% FS	±5% FS	±5% FS	±5% FS
Body Materials	Polycarbonate	Polycarbonate	Polycarbonate	Polycarbonate	Polycarbonate	Polycarbonate
Process Connection	1/2" male NPT in-line or 90° elbow connections	1/2" male NPT in-line or 90° elbow connections	1/2" or 3/4" male NPT in-line or 1/2" male NPT 90° elbow connections	3/4" male or female NPT in-line or 3/4" male NPT 90° elbow connections	1" male or female NPT in-line or 1" male NPT 90° elbow connections	2" male or female NPT in-line connections
Scale Length	2" (51 mm)	3" (76 mm)	3" (76 mm)	3.5" (89 mm)	4.5" (114 mm)	5.5" (140 mm)

INDUSTRIAL Flowmeters

		
SERIES	IF*	HF
Ranges	1.2 to 250 SCFM air (35 to 7080 LPM air); 0.25 to 116 GPM water (0.95 to 439 LPM water)	2 to 22 SCFM air; 0.5 to 25 GPM oil; 0.05 to 116 GPM water
Accuracy	±3% FS	±4% FS
Body Materials	Glass flow tube	Aluminum, brass, or 304 SS
Temperature Limits	200°F (93°C)	240°F or 400°F (115° or 204°C)
Pressure Limits	200 psi (13.8 bar); some models 125 psi (8.6 bar)	600 psi to 6000 psi (41 to 413 bar)
Process Connection	1/2", 1" or 2" female NPT back connections	1/8" to 2" female NPT back connections
Scale Length	4-3/4" (120 mm)	1-1/2" to 2-1/4" (38 to 57 mm)

***CALIBRATION SERVICES AVAILABLE**

These Selection Guides are for quick comparison of similar products. Please refer to the catalog page number referenced for complete product information and specifications.

PADDLE AND THERMAL STYLE

Flow Switches





							
SERIES	V4	V6	V7	V10	V8	FS-2	TDFS2
Service	Gases or liquids	Gases or liquids	Liquids	Gases or liquids	Liquids	Liquids	Liquids
Set Point Range	3 to 2400 GPM (12 to 9000 LPM); 17 to 10000 SCFM (8 to 4700 LPM)	.03 to 10 GPM (.11 to 38 LPM); .15 to 43 SCFM (4 to 1200 LPM)	7.5 to 58.0 GPM (28.4 to 218 LPM)	2.3 to 9.5 GPM (8.7 to 36 LPM); 8.8 to 50 SCFM (250 to 1420 LPM)	6.8 to 58 GPM (25.7 to 218 LPM)	4 to 396 GPM (15 to 1500 LPM)	0.5 to 10 ft/s (0.15 to 3 m/s)
Wetted Materials	Brass, 430 SS, 316 SS**	Brass or 303 SS, 301 SS, 302 SS, ceramic**	301 SS	Brass or 303 SS, 316 SS, 301 SS, 302 SS, ceramic	Brass or 316 SS, 301 SS, 302 SS, ceramic	Tin-Bronze, brass, SS	316 SS
Temperature Limits	-4 to 400°F (-20 to 205°C)	-4 to 400°F (-20 to 205°C)	250°F (121°C)	200°F (93°C)	-40 to 250°F (-40 to 121°C)	230°F (110°C)	140°F (60°C)
Pressure Limits	5000 psig (345 bar)	2000 psig (138 bar)	2000 psig (138 bar)	2000 psig (138 bar)	250 psig (17.2 bar)	145 psig (10.0 bar)	300 psig (20.67 bar)
Adjustable Set Point	Yes	Yes	Yes	Yes	Yes	Yes	Yes
Power Requirement	None	None	None	None	None	None	9-24 VDC
Enclosure Rating	WP and EXP	WP and EXP	WP	WP	WP	WP	NEMA 4X (IP65)
Switch Type	SPDT or DPDT	SPDT or DPDT	SPDT	SPST	SPDT	SPDT	1 NO NPN, 1 NC NPN
Process Connection	1-1/2" male NPT** or 1-1/2" male BSPT	1/2" male NPT** or 1/2" male BSPT	1" male NPT	1/2" male NPT** or 1/2" male BSPT	1" male NPT	1" male NPT or BSPT	1" male NPT
Agency Approvals	ATEX, CE, CSA, FM, IECEx, UL***	ATEX, CE, CSA, IECEx, KTL, UL	CE, UL	CE, CSA, UR	CE, cURus	CE	CE

**Other options available, contact factory

***No housing option (-NH) has no approvals

PISTON STYLE

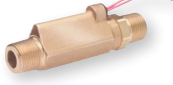
Flow Switches

						
SERIES	P2	P3	P1	P8	GVS	AFS
Service	Gases or liquids	Liquids	Liquids	Liquids	Liquids	Gases or liquids
Set Point Range	.05 to 1 GPM (.2 to 3.79 LPM); .42 to 5 CFM (11.9 to 141 LPM)	.25 to 2 GPM (.95 to 7.57 LPM)	.1 to 1.5 GPM (.38 to 5.7 LPM)	.25 to 2 GPM (.95 to 7.57 LPM)	1 to 8 GPM (3.8 to 30.3 LPM)	1 to 75 SCFM @ 5 psi (28 to 2123 LPM @ 5 psi); .5 to 20 GPM (2 to 75.5 LPM)
Wetted Materials	PPE and PS, epoxy, 316 SS	Polypropylene, PPS composite, 316 SS, fluorocarbon	Brass, polysulfone, 316 SS, fluoroelastomer, epoxy	Brass, PPS composite, epoxy, 316 SS, fluorocarbon	Bronze, TFE, 316 SS, fluoroelastomer, ceramic	316 SS, fluoroelastomer, epoxy, brass
Temperature Limits	0 to 212°F (-18 to 100°C)	0 to 212°F (-18 to 100°C)	-20 to 225°F (-29 to 107°C)	-20 to 275°F (-28 to 135°C)	-20 to 200°F (-29 to 93°C)	-20 to 300°F (-29 to 149°C)**
Pressure Limits	150 psig (10.3 bar) @ 70°F (21°C); 50 psig (3.4 bar) @ 212°F (100°C)	125 psig (8.6 bar) @ 70°F (21°C); 50 psig (3.4 bar) @ 212°F (100°C)	1000 psig (69 bar)	1500 psig (103 bar)	400 psig (27 bar) @ 100°F (38°C)	1000 psig (69 bar)
Adjustable Set Point	No	No	No	No	Yes	Yes
Power Requirement	None	None	None	None	None	None
Enclosure Rating	GP	GP	GP	GP	GP	GP
Switch Type	SPST, NO	SPST, NO	SPDT	SPST, NO	SPDT	SPDT
Process Connection	1/4" male NPT	3/8" male NPT or 1/4" Quick Disconnect	1/4" female NPT	3/8" male NPT	1" female NPT	1/2" female NPT
Agency Approvals	CE	CE	CE	CE	CE	CE

**Other options available, contact factory

PADDLE WHEEL/TURBINE/MULTI-JET

Flow Transmitters



SERIES	PFT	SFI-100T	DFMT
Service	Liquids	Liquids	Liquids
Wetted Materials	Brass or 316 SS	Brass	PVDF
Accuracy	±1% FS	±5% FS	±1.5% FS
Temperature Limits	212°F (100°C)	-20 to 212°F (-29 to 93°C)	194°F (90°C)
Pressure Limits	400 psig (27.6 bar)	125 psig (8.6 bar)	145 psi (1.0 mPa)
Pipe Size	1-1/2 to 40" (38.1 to 1016 mm)	1/2" or 3/4" (12.7 mm or 19 mm)	3/8", 1/2", 3/4", 1", 1-1/2" or 2" (9.5 mm, 12.7 mm, 19 mm, 25.4 mm, 38 mm or 50.8 mm)
Flow Rate	1.2 to 25 ft/s (0.37 to 7.62 m/s)	2 to 35 GPM (7.6 to 132.5 LPM)	0.44 to 176.11 GPM (0.1 to 40 m³/h)
Output	4-20 mA or pulsed	Pulsed	4-20 mA or pulsed

FLOW

Water Meters



SERIES	WMH	WMT2	WPT
Service	Water	Water	Water
Wetted Materials	Body and couplings: Brass; Measuring chamber: ABS plastic	Body and couplings: Brass; Measuring chamber: ABS plastic	Body: Nylon 66; Couplings: Nylon 66, 1-1/2" (40 mm) sizes lead free ECO BRASS®; Measuring chamber: ABS plastic
Accuracy	WMH-A-X-XX: Transitional flow: ±3%; Nominal flow: ±1.5%	±2% FS	WPT-A-X-XX: Transitional flow: ±3%; Nominal flow: ±1.5%
Temperature Limits	190°F (88°C)	104°F (40°C)	122°F (50°C)
Pressure Limits	150 psi (10 bar)	232 psi (16 bar)	150 psi (10 bar)
Pipe Size	5/8" x 1/2" to 2" (15 mm to 50 mm)	1/2" to 2" (12.7 mm to 50 mm)	5/8" x 1/2" to 1-1/2" (15 mm to 40 mm)
Flow Rate	20 to 160 GPM (3 to 30 m³/h)	20 to 160 GPM (3 to 30 m³/h)	20 to 160 GPM (3 to 30 m³/h)
Output	Pulsed	Pulsed	Pulsed

These Selection Guides are for quick comparison of similar products. Please refer to the catalog page number referenced for complete product information and specifications.

ULTRASONIC Flow Transmitters



SERIES	UFM*	PUB*
Service	Liquids	Liquids
Wetted Materials	N/A	N/A
Accuracy	±3% of reading	±2% FS
Temperature Limits	185°F (85°C)	275°F (135°C)
Pipe Size	0.98 to 4.62" (24.89 to 117.35 mm)	0.5 to 78" (13 to 2000 mm)
Flow Rate	0.33 to 32.8 ft/s (0.1 to 10 m/s)	0.33 to 65.62 ft/s (0.1 to 20 m/s)
Output	4-20 mA and pulsed	4-20 mA, 0-16 mA or 0-20 mA and pulsed
Enclosure Rating	NEMA 4X (IP66)	NEMA 4X (IP66)

FLOW Heat Meters



SERIES	TUF	IEFB*
Services	Clean, compatible liquids	Compatible clean or dirty non coating, conductive liquids
Wetted Materials	Brass and 316L SS	316 SS, polystyrene and Silicon
Range	Refer to flow rate below	0 to 20 ft/s (0 to 6 m/s)
Accuracy	BTU: EN1434/CJ128 CLASS 2; Flow: $\pm(2+(0.02 Q_p/Q))$	BTU: RTD and calculator meet EN1434 Class B; Flow: 1% of reading or 1% FS (model dependant)
Temperature Limits	36 to 203°F (2 to 95°C)	32 to 250°F (0 to 121°C)
Pressure Limits	362 psi (25 bar) (model dependant)	400 psi (27.6 bar)
Pipe Size	1/2 to 8" (15 to 200 mm)	4 to 36" (101 to 914 mm) (model dependant)
Flow Rate	0.1 to 881 GPM (0.5 to 3333 LPM)	Refer to velocity range above
Output	BACnet, Modbus® or M-BUS (model selectable)	(1) Analog (1) Pulse/frequency (1) Empty Pipe detection/ min. or max velocity trigger (1) Reverse flow pulse output indication (1) BACnet or Modbus®

Modbus® is a registered trademark of Schneider Automation, Inc.

***CALIBRATION SERVICES AVAILABLE**

These Selection Guides are for quick comparison of similar products. Please refer to the catalog page number referenced for complete product information and specifications.



ELECTROMAGNETIC, IN-LINE/INSERTION

Flow Transmitters



SERIES	UFB*	MFS	IEF*
Service	Liquids	Liquids	Liquids
Wetted Materials	N/A	316 SS	316 SS
Accuracy	±2% of reading	±2% of reading	0.5% of reading, 1% of reading or ±1% FS
Temperature Limits	275°F (136°C)	194°F (90°C)	15 to 250°F (-9 to 121°C)
Pressure Limits	N/A	232 psi (16 bar)	400 psi (27.6 bar)
Pipe Size	0.05 to 79" (13 to 2000 mm)	1/2 or 1" (12.7 or 25 mm)	4 to 36" (101 to 914 mm)
Flow Rate	0.33 to 33 ft/s (0.1 to 10 m/s)	0.25 to 52.8 GPM (1 to 200 LPM)	0 to 20 ft/s (0 to 6 m/s)
Output	4-20 mA, 0-16 mA or 0-20 mA	4-20 mA or pulsed	(1) Analog: 4-20 mA, 0-5 V, 0-10 V or 2-10 V (display selectable); (1) Pulse/Frequency: 0-15 V peak pulse, 0-500 Hz or scalable pulse output (display selectable); (2) Alarm: (1) Empty pipe detection or minimum/maximum velocity, (display selectable); (1) Reverse flow output indication

*CALIBRATION SERVICES AVAILABLE

These Selection Guides are for quick comparison of similar products. Please refer to the catalog page number referenced for complete product information and specifications.



Designers of a bio-medical incubator rely on a Dwyer® flowmeter to control CO₂ flow

This low temperature incubator with CO₂ atmosphere is used in bio-medical applications, such as short term blood work and long term tissue culture studies. CO₂ is introduced at a high initial purge rate controlled by a timer. After the purge period, a Dwyer® Visi-Float® flowmeter with a metering valve is utilized to adjust and monitor the CO₂ flow in cubic centimeters per minute. The Visi-Float® flowmeter provides the reliability and accuracy needed to complement the host of high performance features designed into this incubator.

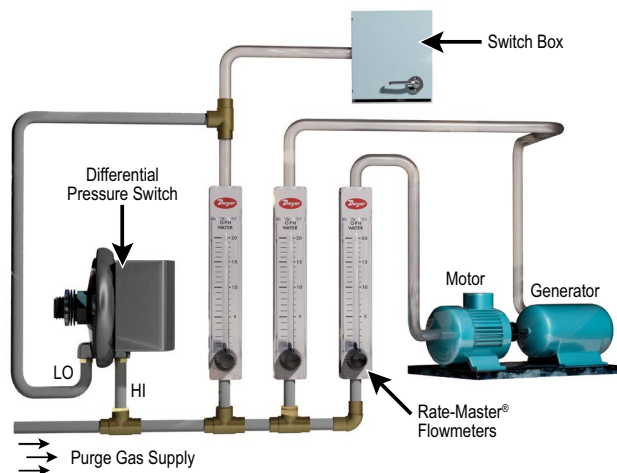

Flowmeters and/or differential pressure switches monitor vital purge gas flow to motors, switchgear, instruments

To purge motors, generators, switchgear, and industrial instrument cases, Dwyer® flowmeters are installed in the supply line to indicate a flow of air, manufactured inert gas, or nitrogen to these devices. The flowmeters (with valves) allow maintenance personnel to set the flow quickly and recheck anytime to make sure proper flow continues. A Dwyer® differential pressure switch can also be used to monitor proper flow on a continuous basis and provide a signal or alarm if purge gas flow fails. Such an optional switch is shown above, monitoring proper flow of purge gas to the switchbox as a function of pressure drop across the flowmeter. The purging of electrical equipment in hazardous areas may require more extensive control and monitoring devices.

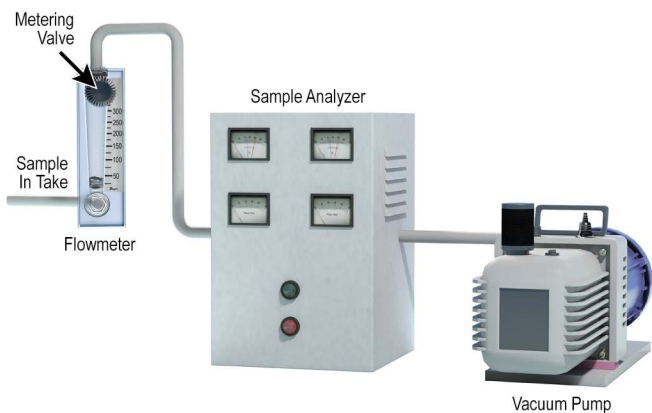

Metering valves on Dwyer® flowmeters control air/gas intake on permanent air pollution analyzers

Regulations regarding air pollution levels require continuous monitoring a source and ambient pollutants in areas where noxious gases are generated. Ambient air quality samplers utilize either Visi-Float® or Rate-Master® flowmeters to establish the proper flow of sample or carrier gases into the analyzer. Top mounted metering valves are recommended for flowmeters used in vacuum service to maintain specified accuracy.

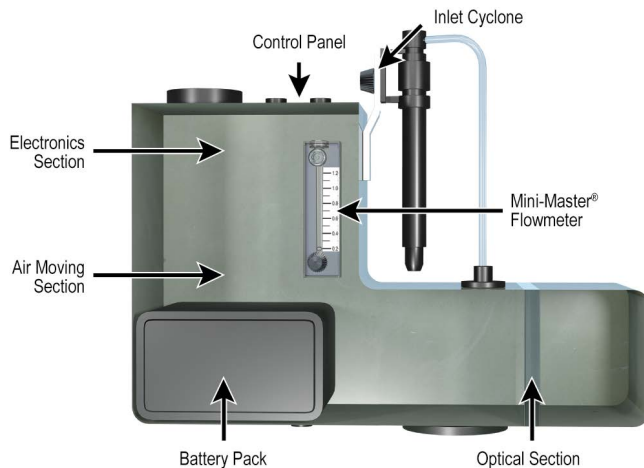

Operator uses Mini-Master® flowmeter to verify air flow into portable dust monitor

The small size, accuracy, and low cost of the Dwyer® Mini-Master® flowmeter lends itself perfectly to use in this portable, battery-operated dust monitor. Using a light scattering electronic sampler, a small vacuum pump draws air through the flowmeter into the sampling chamber, and the flowmeter verifies the proper volume of sample air flow. Readout is digital and directly in dust weight per cubic meter of air.

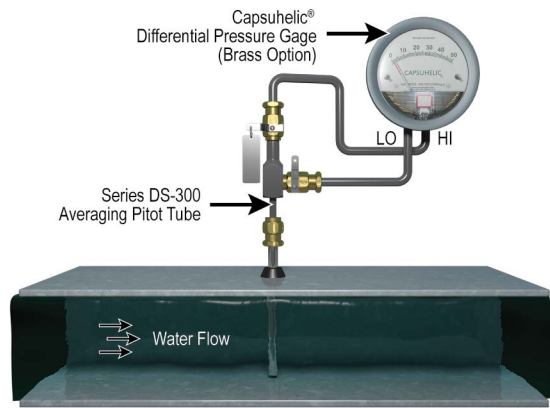

Brass body gage measures water flow rates

A Dwyer® brass body Capsuhelic® differential pressure gage, required for water service to prevent corrosion damage to the gage, is used in conjunction with a Dwyer® Series DS-300 averaging Pitot tube. The Capsuhelic® gage provides a basic method of measuring water flow rates. As a guide in selecting the appropriate Capsuhelic® gage range, the designer can consult data provided with the DS-300 averaging Pitot tube. This relates differential pressure in inches of water column to the water flow in gallons per minute for the pipe size involved. The gage can be calibrated directly in GPM if desired. Bleed fittings installed in the top ports of the gage are recommended to facilitate removal of air from the system.

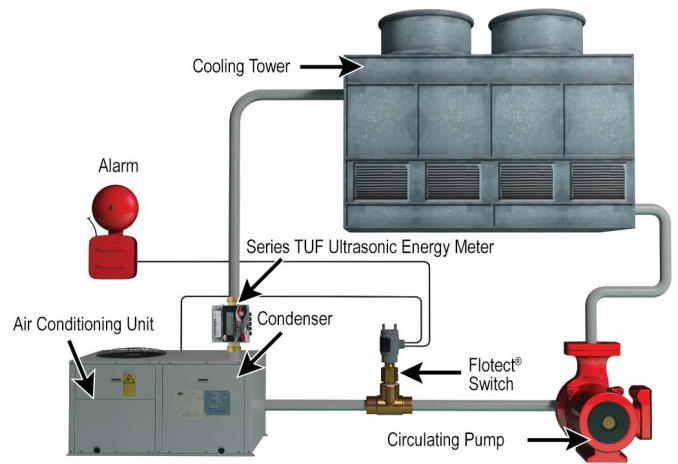

Flotect® flow switch ensures cooling water circulation before air conditioning compressor motor starts and Series TUF monitors thermal energy loss from cooling tower to air condenser

Large air conditioning and refrigeration systems which include water cooled condensers require that the water must circulate through the condenser and cooling tower in sufficient volume before the compressor is started. Here the W.E. Anderson® Flotect® flow switch is connected to the compressor control circuit to prevent starting or to shut down the compressor control circuit if the flow of cooling water falls below that required for proper operation. A dual Flotect® switch (available as an option) will also trigger a remote alarm to signal the operator of the shutdown as soon as it occurs. The Series TUF monitors the water flow as well as the temperature of the water going into and out of the air conditioning unit in order to calculate the cooling efficiency of the air conditioning unit.

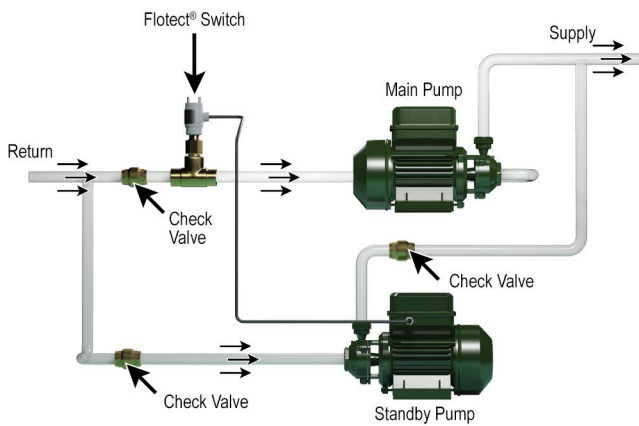

When main pump fails, Flotect® flow switch transfers to standby pump to maintain vital fluid circulation

When proper fluid circulation in a system is critical, the W.E. Anderson® Flotect® flow switch will automatically start a standby pump should the main pump fail. The flow in the main path of the parallel system illustrated keeps the Flotect® flow switch in an open position. When the main pump fails, the flow will cease. The flow switch then closes, starting the standby pump.

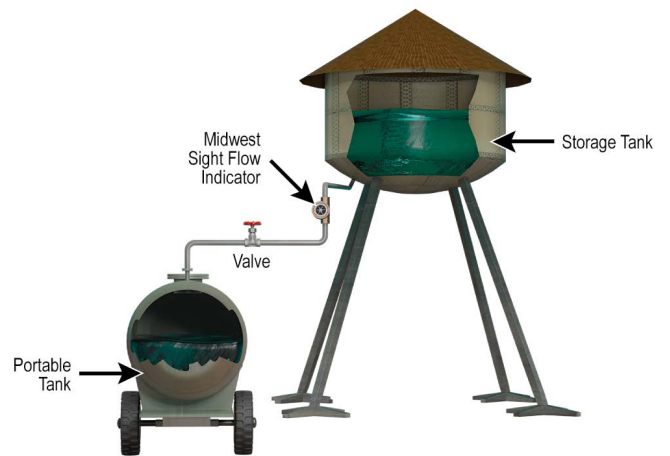

W.E. Anderson® Midwest Sight Flow Indicator reveals flow or stoppage

In this gravity feed system delivering liquid fertilizer to portable tanks, a Series SFI-100 MIDWEST sight flow indicator was installed. The operator can see the rotating vanes to check for adequate flow at any time.



Flows of air and gases used in a special furnace are controlled by Dwyer® flowmeters

A total of eleven Dwyer® Rate-Master® flowmeters function in the design of this sophisticated conveyor belt furnace used in manufacturing electronic devices. The flowmeters provide precise adjustment and monitoring of the flows of air and gases into the various portions of the furnace, which allow it to perform different operations, such as decarburizing and oxidizing, metallic package sealing, glass package sealing, and glass-to-metal sealing.

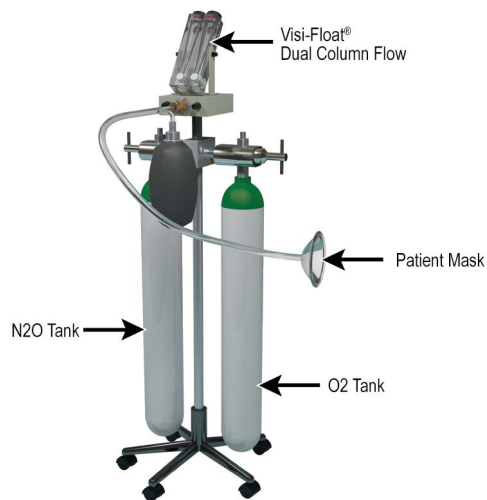

Durable dual-column flowmeter adds value for physicians and oral surgeons

Physicians and oral surgeons who use anesthesia or analgesia in their offices on an occasional basis require a system that is reliable but small and portable. One such system employs special Dwyer® dual-column Visi-Float® flowmeters to meter and monitor precise flows of nitrous oxide and oxygen to the patient. In addition to meeting the performance level demanded by this application, the Visi-Float® flowmeters are durable and attractive complements to this important and visible medical device.



Salt corrosion test cabinet includes a Dwyer® flowmeter for adjustment of bubbler air flow

Prior to atomizing a heated salt solution to produce a fog inside this corrosion test cabinet, compressed air is bubbled through a heated water column to properly heat and humidify the air. A Dwyer® Visi-Float® VFA flowmeter, as part of the system, provides precise adjustment of the bubbler air flow to meet test standards.

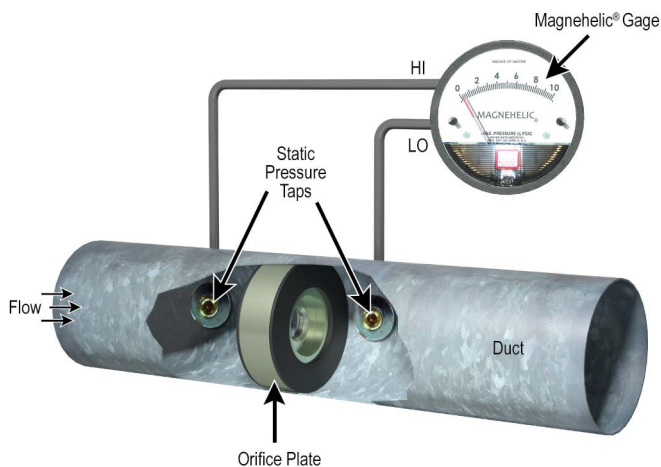





Measuring air velocity with an orifice plate

In this set-up, the Magnehelic® gage measures higher air velocities as a function of the pressure drop across a sharp-edged orifice plate in the pipe. The pressure drops can be converted to air velocity using orifice plate data supplied by the manufacturer. Details regarding available sizes, ranges, installation, and limitations are available from orifice plate manufacturers and from standard handbooks. A Dwyer® Durablock® inclined manometer or Photohelic® differential pressure switch/gage can also be used. In addition to the visual reading gage, the Photohelic® switch/gage provides an alarm signal or shutdown control function. Pressure sensing taps should be located on the side or top of the pipe or duct to prevent condensation from draining into sensing lines or gages.

LIQUID

Level Switches

				
SERIES	L4	L6	L8	L10
Service	Liquids	Liquids	Liquids	Liquids
Wetted Materials	316 SS	304 SS	316 SS	304 SS
Temperature Limits	275°F (135°C)	220°F (105°C)	212°F (100°C)	200°F (93°C)
Pressure Limits	2000 psig with option bar	2000 psi (138 bar)	150 PSIG (10.34 bar)	2000 (137.137.8 bar)
Process Connection	1-1/2" or 2-1/2" male NPT	1" male NPT or 1" female NPT with external float	1" male NPT	1" male NPT
Min. Specific Gravity	0.7	0.9	0.6	0.9
Output	SPDT or DPDT	SPDT or DPDT	SPDT	SPST
Mounting Orientation	Horizontal with optional vertical	Horizontal	Horizontal	Horizontal
Agency Approvals	ATEX, CE, CSA, FM, IECEx, UL	ATEX, CE, CSA, FM, IECEx, KTL, UL	CE, cURus	CSA, UR





LIQUID

Level Switches

					
SERIES	F7-MS	123	102	CFS2	FSW2
Service	Liquids	Liquids	Liquids	Liquids	Liquids
Wetted Materials	Brass or 316 SS	304 SS	Cast iron	Polypropylene	Polypropylene
Temperature Limits	Buna-N floats: 180°F (82.2°C) in oil, 230°F (110°C) in water; SS floats: 300°F (148.9°C)	365°F (185°C)	425°F (218°C)	122°F (50°C)	122°F (50°C)
Pressure Limits	750 psi (51.7 bar)	150 psig (10.34 bar)	400 psig (27.6 bar)	14.5 psi (1 bar)	29 psi (2 bar)
Process Connection	1/2", 1-1/4", 2", or 3" 150# flange	1" female NPT	1" female NPT	N/A	N/A
Min. Specific Gravity	0.55	0.88	0.6	0.6	0.6
Output	SPST or SPDT	SPDT, DPDT or (2) SPDT	SPDT, DPDT or (2) SPDT	SPST or SPDT	SPST or SPDT
Mounting Orientation	Vertical ±30°	Vertical	Vertical	Horizontal	Vertical
Agency Approvals	N/A	CSA, UL	UL	CE, UL/CSA	CE





These Selection Guides are for quick comparison of similar products. Please refer to the catalog page number referenced for complete product information and specifications.

LIQUID Level Switches

				
SERIES	F7-MLK	F6 & F7	F6 & F7	F7-MM
Service	Liquids	Liquids	Liquids	Liquids
Wetted Materials	Buna-N/Brass	Polypropylene, 316 SS, or Buna-N*	Polypropylene, 316 SS, or Buna-N*	Brass or 316 SS
Temperature Limits	221°F (105°C)	176°F (80°C) or higher*	176°F (80°C) or higher*	180°F (82.2°C) or higher*
Pressure Limits	150 psig (10 bar)	50 psig (3 bar) or higher*	15 psig (1 bar) or higher*	1000 psi (68.95 bar)
Process Connection	2" male NPT	M16x2, 18" male NPT, 1/2" male NPT, 3/4" female NPT, or 3/8"-24" UNF-2A*	1/8" or 1/4" male NPT*	1/8", 3/4", or 1" male NPT, 3-5/8" flange, 1-5/16-12UNF-2A, 3/8"-24 thread, or 2" male NPT with 1/2" conduit
Min. Specific Gravity	0.45	0.45 or higher*	0.45 or higher*	0.45
Output	SPST	SPST	SPST	SPST
Mounting Orientation	Vertical	Horizontal	Vertical	Vertical
Agency Approvals	N/A	N/A	CE, UL*	N/A

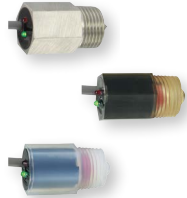
*Varies per product

LIQUID Level Switches

				
SERIES	OLS	B-190	CLS2	CLS1
Service	Liquids	Liquids	Liquids, powder, bulk materials	Solids, liquids, slurries
Wetted Materials	316 SS, Polysulfone or PFA	316 SS	316 SS	CPVC
Temperature Limits	200°F (93.3°C)	200°F (93.3°C)	185°F (85°C)	240°F (116°C)
Pressure Limits	1000 psig (69 bar)	125 psig (8.6 bar)	365 psi (25 bar)	30 psig (2.06 bar)
Process Connection	1/2" male NPT	4" 125 # cast iron flange	3/4", 1", or 1-1/2" male NPT or BSPT or 1-1/2" or 2" sanitary clamp	1" male NPS
Min. Specific Gravity	N/A	0.5	N/A	N/A
Output	NPN open collector	SPST or SPDT	DPDT	SPDT
Mounting Orientation	Any position	Vertical	Vertical or horizontal	Vertical or horizontal
Agency Approvals	N/A	UL	CE, cULus	N/A

These Selection Guides are for quick comparison of similar products. Please refer to the catalog page number referenced for complete product information and specifications.





BULK

Level Switches

					
SERIES	CLS2	CLS1	VRLS	TFLS	CTF
Service	Liquids, powder and bulk	Liquids, slurries, powder and bulk	Powder and bulk	Powder and bulk	Powder and bulk
Sensing Technology	Capacitance	Capacitance	Vibrating rod	Vibrating tuning fork	Vibrating tuning fork
Wetted Materials	316 SS	CPVC	304 SS	316 SS	304 SS
Temperature Limits	185°F (85°C)	240°F (116°C)	176°F (80°C)	176°F (80°C)	212°F (100°C)
Pressure Limits	365 psi (25 bar)	30 psig (2.06 bar)	150 psi (10 bar)	145 psig (10 bar)	600 psi (40 bar)
Process Connection	3/4", 1", or 1-1/2" male NPT or BSPT or 1-1/2" or 2" sanitary clamp	1" male NPS	1" male NPT	1-1/2" male NPT	1" male NPT
Output	DPDT	SPDT	SPDT	SPDT	PNP/NPN
Mounting Orientation	Vertical or horizontal	Vertical or horizontal	Vertical or horizontal	Vertical or horizontal	Vertical or horizontal
Agency Approvals	CE, cULus	N/A	N/A	N/A	N/A





SUBMERSIBLE

Level Transmitters





				
SERIES	SBLT2/SBLTX	MBLT	PBLT2/PBLTX	FBLT
Service	Liquids	Liquids	Liquids	Liquids
Wetted Materials	316 SS	316 SS	316 SS	316 SS
Temperature Limits	150°F (66°C)	176°F (80°C)	PBLT2: 180°F (82°C) PBLTX: 176°F (80°C)	176°F (80°C)
Pressure Limits	2x FS	2x FS	2x FS	2x FS
Accuracy	±0.25% FS	±0.25% FS	±0.25% FS	±0.25% FS
Range	0 to 300 psi (10 to 693 ft w.c) (3.2 to 211 m w.c)	0 to 300 psi (10 to 693 ft w.c) (3.2 to 211 m w.c)	0 to 300 psi (10 to 693 ft w.c) (3.2 to 211 m w.c)	0 to 300 psi (10 to 693 ft w.c) (3.2 to 211 m w.c)
Output	4-20 mA	4-20 mA or 0 to 5 V	4-20 mA	4- 20 mA
Agency Approvals	SBLT2: CE SBLTX: CE, cULus	CE	PBLT2: CE PBLTX: CE, cULus	CE

These Selection Guides are for quick comparison of similar products. Please refer to the catalog page number referenced for complete product information and specifications.

BULK Level Switches

				
SERIES	DBLM	PLS2	PLS	ULTRA-MAG™
Service	Powder and bulk	Powder and bulk	Powder and bulk	Powder and bulk
Sensing Technology	Rotating paddle	Rotating paddle	Rotating paddle	Magnetic linkage and diaphragm
Wetted Materials	Polycarbonate	304 SS	316 SS	Aluminum or 304 SS with urethane, Buna-N, PTFE, silicone rubber, polyester, fluoroelastomer, white Buna-N or EPDM diaphragm
Temperature Limits	140°F (60°C)	176°F (80°C)	300°F (148.9°C)	350°F (176°C)
Pressure Limits	N/A	11.6 psi (0.8 bar)	30 psig (2.07 bar)	60 psig (4.14 bar)
Process Connection	3/4" male NPT, optional flange and 1-1/4" to 3/4" reducer	1-1/4" male NPT	1-1/4" male NPT, optional flange	8-3/8" (212.73 mm) diameter bolt hole circle
Output	SPDT	SPDT	SPDT or DPDT	SPDT
Mounting Orientation	Vertical or horizontal	Vertical or horizontal	Vertical or horizontal	Vertical
Agency Approvals	CE	CE, FM	cUL	CSA, UL

CAPACITIVE, ULTRASONIC AND FLOAT Level Transmitters

				
SERIES	CRF2	CLT	ULT	ULSS/ULSM/ULSL
Service	Liquids, powders, bulk material	Liquids	Liquids	Fluids/liquids
Wetted Materials	316 SS	Brass	303 SS	PVDF, FKM
Temperature Limits	Ambient: 185°F (85°C); Process: 250°F (121°C)	180°F (82°C) in water, 230°F (110°C) in oil, 230°F (110°C) SS floats	140°F (60°C)	140°F (60°C)
Pressure Limits	100 psi (6.9 bar)	150 psig (10 bar)	30 psi (2 bar)	30 psi (2 bar)
Accuracy	±0.25% FS	±1 mm	±0.2% FS	ULSS: ±0.125" (3 mm); ULSM/ULSL: ±0.2% FS
Range	12 to 30 ft (3.7 to 9.1 m)	Options from .5 to 68" (0.01 to 1.73 m)	0 to 24.6 ft (0 to 7.5 m) or 0 to 32.8 ft (0 to 10 m)	ULSS: 0 to 4.1 ft (0 to 1.25 m); ULSM: 0 to 9.8 ft (0 to 3 m); ULSL: 0 to 18 ft (0 to 5.5 m)
Output	4-20 mA	4-20 mA or 0-5 V	4-20 mA	4-20 mA
Agency Approvals	N/A	N/A	CE, FM	CE

These Selection Guides are for quick comparison of similar products. Please refer to the catalog page number referenced for complete product information and specifications.

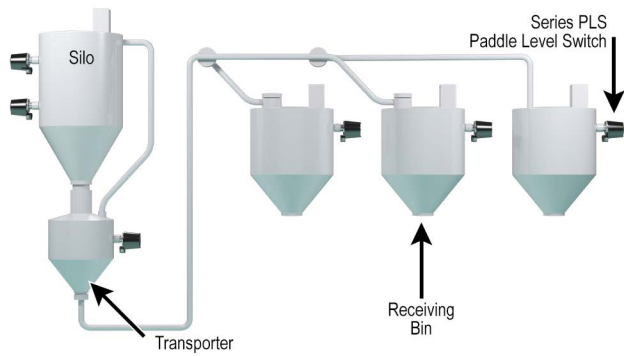

Proximity® Series PLS is used to indicate level status in pneumatic conveying systems

Pneumatic conveying systems use air to transport powder and dry bulk solids through conveying lines. The air is pressurized by positive pressure or vacuum to move the product through the lines into and out of silos, transporters, and receivers. Typical applications have high and low level indication in the storage bins to control the flow of product in or out. The Series PLS is perfect for level use in these storage bins. It has a rotating paddle that is inserted into the bin. As the product level builds up in the bin it stops the paddle from rotating and triggers the level output. The Series PLS is great for this application as it is not affected by pressure changes in the bin.

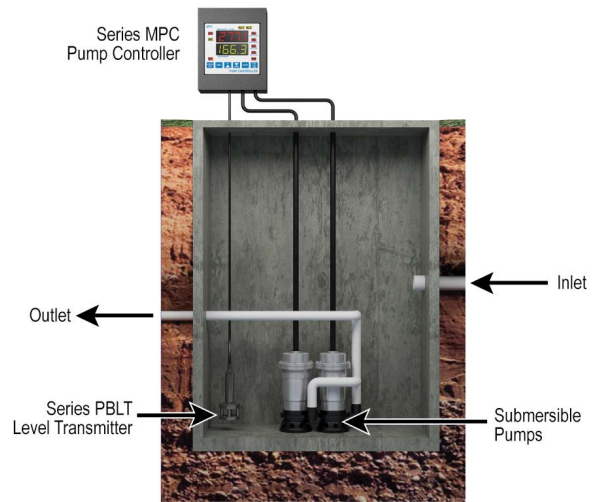

Mercoid® pump controller with level transmitter control pumps in wastewater lift stations

Lift stations are used to transmit wastewater to the treatment facility. Wastewater is transmitted by gravity feed so it has to be continually elevated to provide height to generate the flow. Lift stations are pits located at points in the wastewater system to collect the wastewater that usually have two submersible pumps. Wastewater in the lift station is pumped out to a higher level from where it can flow on to the next lift station or to the treatment facility. The Mercoid® Series MPC pump controller is used with the Series PBLT level transmitter to control the level in the lift station. The Series PBLT is a level transmitter that is submersed in the tank and sends a linear output of the height of wastewater above it. The Series MPC takes the height input and controls the pumps according to how it has been programmed.

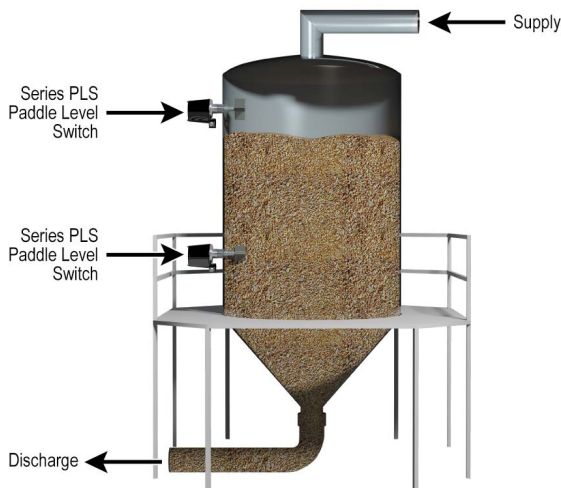

Grain hopper level controlled by Series PLS Paddle Level Switch

The supply of grain pneumatically conveyed to this dispensing hopper is controlled by two Proximity® Series PLS paddle level switches. When the grain level falls to the low limit switch, the supply is turned on until the hopper fills to the level of the high limit switch which turns off the supply. Since grain dust is explosive, the explosion-proof Series PLS provides the required safety protection. The Series PLS is a paddle level switch and is not affected by the varying pressure in the hopper due to the cycling of the pneumatic conveying system.

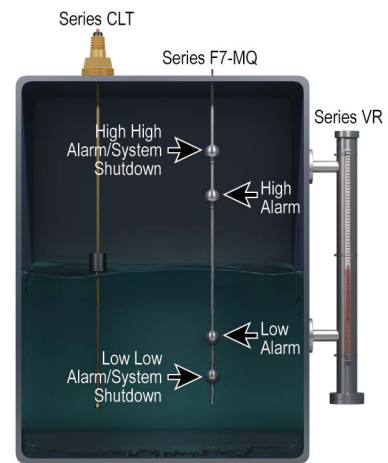

Custom level sensing devices are built to meet each customer's specific requirements, providing visual indication, continuous measurement, and point level control

To meet various tank level measuring needs, Dwyer Instruments, Inc. offers custom-configured products built to customer specifications that provide visual indication, continuous level measurement, and multiple point level measurement. Series VR or MVR View-Rite Level Indicators are a safe way to keep the process isolated while providing true visible indication. Unlike sight glasses, which can crack or break, View-Rite Indicators contain liquids entirely within their stainless steel enclosure. For continuous level measurement needs, the Series CLT uses reed switch technology to offer a more economical solution than expensive ultrasonic, submersible or RT transmitters. Lastly, the Series F7-MQ can be used in virtually any tank to indicate high and low alarms or to control pumps and valves.

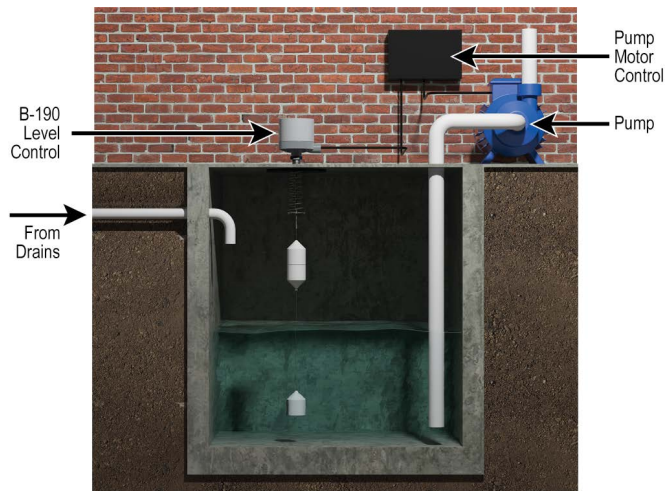

Mercoid® displacer type level control is ideal for controlling industrial sump pumps

Industrial sumps and other underground tanks are ideal applications for top-mounted Mercoid® displacer type level controls. Easily installed, these controls use porcelain displacers that do not float on the surface of liquids, but are suspended on a coil spring and cable. As the liquid in the tank reaches the level of the upper displacers, their weight decreases by an amount equal to the liquid displaced, allowing the spring to move the cable upward, actuating the switch and the pump is turned on. As the liquid level falls below the upper displacers they move only a small amount, staying within the switch deadband until the liquid level falls to the center of the bottom displacer. At this point the switch is deactivated stopping the pump. The pump will remain deactivated until the water level rises to the upper displacers, repeating the cycle. The displacers are not affected by turbulence, pressure or chemicals and are excellent for tanks with viscous or dirty liquids. The level differential is easily adjusted by repositioning of the displacers on the 316 SS cable.

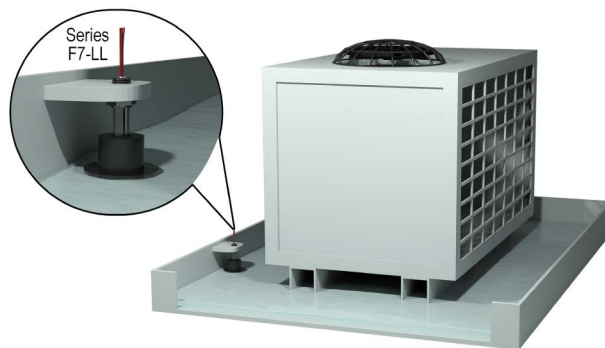

Low level float switch enables sensing in air conditioner drip pans and other shallow level applications

Standard float switches require at least an inch of liquid to attain enough buoyancy to switch. This can be a problem in applications where low level sensing is required. The hat-shaped design of the W.E. Anderson® Series F7-LL provides necessary buoyancy for switching in only 5/8" of water. This is essential for air conditioner drip pans, low level sumps, and drains. The Series F7-LL is also ideal for low alarms, where running the process dry can result in catastrophic failure.

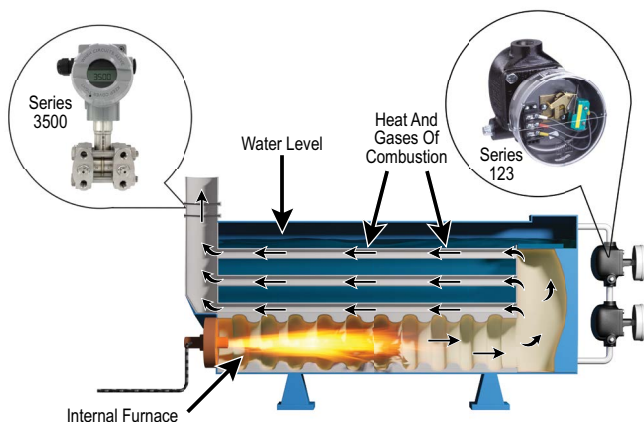

Mercoid® Series 123 level controls provide high and low alarm on large de-aerator tank

Liquid level in the external piping equals level in the tank. When level rises to high limit, float in upper Series 123 is lifted, actuating switch to sound high level alarm. When level drops to low limit, lower Series 123 sounds low level alarm. In addition, a Series 3500 transmitter monitors the flow at the feedwater outlet. This helps to measure the efficiency of the de-aerator system.



W.E. Anderson® Series OLS indicates level in heavy equipment radiator

Many types of heavy industrial equipment use a liquid cooling system for the motor. A vibratory trench roller is a machine that compacts sub-bases for roads, parking lots, etc., and is an example of the type of equipment that would utilize this system. This machine incorporates a radiator cooling system. In the system, cooling liquid circulates through the engine preventing it from over heating. As the engine is cooled the cooling fluid heats up. The fluid returns to the radiator to cool down before being circulated through again. If there is not enough cooling fluid in the system the engine will not be cooled enough and damage will occur. A W.E. Anderson® Series OLS optical level switch is installed as a low level alarm. The level alarm is signaled by the Series OLS before the cooling fluid gets to a critical low level, warning the operator of the problem. The Series OLS uses an optical detection system superior for this application as float controls may trip from machine vibration. Also the compact insertion length is ideal for a small radiator.

PANEL METERS

Displays



SERIES	SPPM2	SPPM	DPM	DPMX
Display	Graphical full color TFT	Graphical full color TFT	3-1/2 digit, or 4-1/2 digit, 7 segment backlit LCD (amber, green or red)	3-1/2 digit, 7 segment backlit LCD (red)
Panel Size	4.3" diag.	2.4", 2.8", 3.5" diag.	2-3/8" by 1-1/8"	10-19/32" by 4-5/32"
Display Units	User defined	User defined	None, °F, °C, %, psi, V, A, KW, PF	None
Input Signal	4 analog (0-50 mA, or 0-40 VDC), 8 digital I/O	0-50 mA, or 0-40 VDC	4-20 mA, 0-200 mVDC, 0-5 VDC, 0-10 VDC	4-20 mA, 0-200 mVDC, 0-5 VDC, 0-10 VDC
Output	2 digital I/O, 4 PWM	None	None	None

SWITCHES AND TRANSFORMERS



Current Sensors



SERIES	SCS	MCS	CCS	MSCS
Type	Current switch	Miniature switch	Current switch	Miniature switch
Case	Solid or split core	Solid core or terminal	Solid or split core	Split core
Range	0.15 A to 200 A	0.5 to 50 A or 0.01 to 1 A	0.5 to 200 A	0.15 to 60 A (0.15 A fixed set point)
Output	1 A @ 30 VAC/DC NO solid state output; Optional 10 A @ 260 VAC (5 A @ 30 VDC) SPST relay	0.3 A @ 130 VAC/DC NO output	0.3 A @ 135 VAC/DC NO output or 1 A @ 240 VAC NO output	1 A @ 30 VAC/DC NO solid state output



PANEL METERS

Displays

			
SERIES	LCI132	PM	LPI
Display	4 digit, 7 segment LED (red)	2 - 6 digit, 7 segment LED (red)	4 digit LCD or LED
Panel Size	1/32 DIN	1/8 DIN	Stand alone
Display Units	None	User defined	None
Input Signal	V (DC), mA (DC) or V (AC), A (AC/DC)	mA, V DC, pulse, open collector, NPN, PNP, switch contact	4-20 mA, Thermocouple, or RTD
Output	None	None, 4-20mA, or Relay	None

SWITCHES AND TRANSFORMERS

Current Sensors

			
SERIES	SSCS	CCT40/50	CCT60/70
Type	Current switch with set point based on motor HP	Current transformer	Current transformer
Case	Split core	Solid or split core	Solid or split core
Range	1 to 100 HP	10/20/50 A or 100/150/200 A	10/20/50 A or 100/150/200 A
Output	1 A @ 30 VAC/DC NO solid state output; Optional 10 A @ 260 VAC (5 A @ 30 VDC) SPST relay	0-5 VDC, 0-10 VDC, or 4-20 mA	4-20 mA, true RMS

POWER SUPPLIES AND TRANSFORMERS

Power Converters



SERIES	APT	A-700	BPS	SCD-PS
Input Voltage	24 VAC, 120 VAC, 240 VAC, 120/208/240/277 VAC, 120/208/240/277/480 VAC, 50/60 Hz	100/120/220/230/240 VAC $\pm 10\%$. 47 to 63 Hz	24 VAC/VDC 50/60 Hz	120 to 240 VAC/VDC, 50/60 Hz
Output Voltage	24 VAC	24-28 VDC regulated	1.5-27 VDC (full wave rectified and regulated) adjustable 1.5-29 VDC	24 VDC $\pm 3\%$
Output Current	20, 40, 75, 100, 150 VA	Options from 0.5 A to 4.8 A	0.5 A or 1.5 A	1 A

POWDER, BULK, DUST COLLECTION, AND PNEUMATIC CONVEYING SENSORS







Particulate Sensors



SERIES	PMT2	PMS
Wetted Materials	316L SS, silicone, and PTFE	316 SS and PFA or 316 SS and ceramic
Process Temperature Limit	-40 to 248°F (-40 to 120°C)	250°F (121°C), 450°F (232°C), 800°F (426°C), or 1200°F (649°C)
Pressure Limit	30 psi	10 or 100 psi
Output	4-20 mA	pA

DUST COLLECTOR PULSE VALVE CONTROLLERS

Timers

						
SERIES	SVT	DCT500A	DCT500ADC	DCT600	DCT1000	DCT1000DC
Output Channels	2, 3, 4, 5, or 6; up to 60 with expansion board. Housing includes pilot solenoid valves	4, 6, or 10	4, 6, or 10	4, 6, 10, 22, or 32	6, 10, or 22; up to 255 with expansion board	6, 10, or 22; up to 255 with expansion board
Input	Dry contact	Dry contact	Dry contact	Dry contact	Dry contact or integral pressure sensor	Dry contact or integral pressure sensor
Power	90-240 VAC or 24 VAC/DC	102-132 VAC	10-35 VDC	85-270 VAC	85-270 VAC	10-30 VDC
Size	See catalog page	4-7/8" by 6-3/4"	4-7/8" by 6-3/4"	4-7/8" by 6-3/4" or 6-7/8" by 8-3/4"	6-7/8" by 8-3/4"	6-7/8" by 8-3/4"
Approvals	CE	CE, cULus	CE	CE, cULus	cULus	CE



Monitor the test environment for accurate laboratory tests

The Love Controls® Model LCR20 dual pen circular chart recorder can be used to monitor the humidity and temperature in an environmental chamber. The 10" chart size makes it easy to see the blue and red pen markings on the chart paper. The recorder takes in most common thermocouples and process inputs for both channels. It is recommended that the LCR20 be used with a Dwyer® RHP series humidity / temperature transmitter for best results.

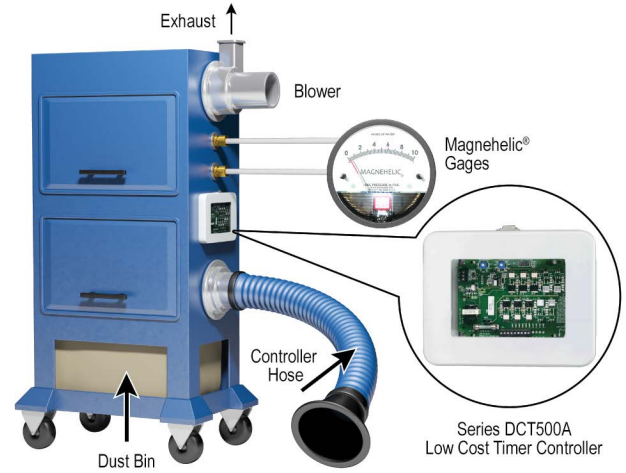

Dust Collector Timer Controller shows filter condition in dust collector

This portable dust collector can be rolled from job to job in an industrial building. An operator places the large diameter collection hose where it is needed and dust is collected by filters located inside the access doors on the units side. The top mounted blower draws air through the filters. To monitor the pressure drop across the filters, the manufacturer supplies a Magnehelic® differential pressure gage. When the pressure drop due to dust build up on the filter indicates that cleaning is necessary, the DCT500A dust collector timer controller is manually activated to initiate a cleaning cycle which involves solenoid valves releasing pulses of air. This process removes the dust from the filters where it drops into a storage bin. A Dwyer® Minihelic® differential pressure gage can be used instead of the Magnehelic® gage, and, if automatic cleaning is required, a Photohelic® differential pressure switch/gage can provide the electrical contact to actuate the cleaning cycle when the pressure drop reaches the preset limit.



Button Data Logger monitors food and beverage temperature in refrigerated transport vehicles

When transporting temperature-sensitive products such as meat, produce, beer and wine over long distances, it is necessary to verify that the storage compartment has not exceeded the critical preservation temperature at any time. Dwyer® BDL button data loggers offer a low cost way to measure and record storage temperatures throughout transport. By placing several "buttons" throughout the storage compartment and setting an appropriate measurement interval, transportation services can retrieve data at the completion of delivery to assure their customers of adequate preservation temperatures.

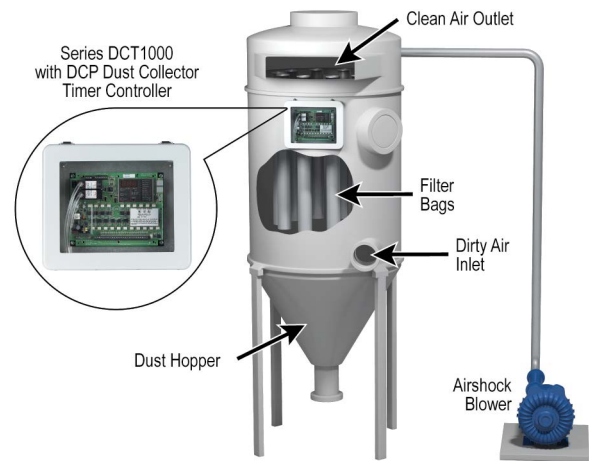

Bag house cleaning system uses Dust Collector Timer Controller to initiate optimum cleaning cycle

A Dwyer® DCT1000 dust collector timer controller with attachable DCP pressure sensing module monitors and controls the dust levels and corresponding pressure drop across the filter bags. The DCT1000/DCP control automatically activates the cleaning cycle when the DCT1000's pre-programmed set points have been exceeded. This on-demand control system alleviates excessive air compressor usage by preventing unnecessary cleaning which lowers energy and maintenance costs.

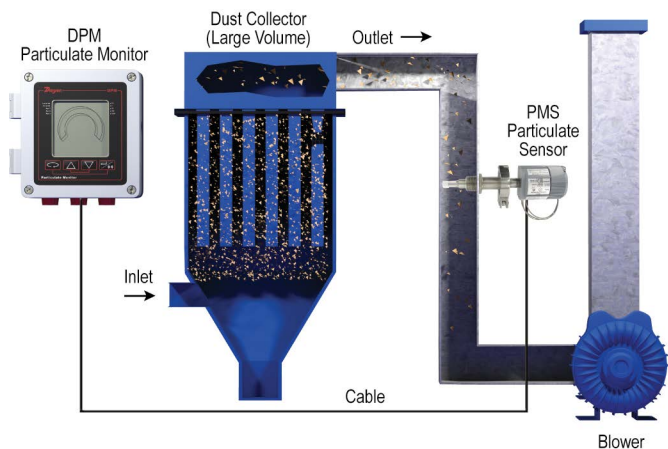

Detect broken filters in dust collectors

The Dwyer® Series DPM particulate monitor and PMS particulate sensor combine to make a particulate monitoring system for the exhaust stream of dust collectors. The amount of particulate leaking out of the dust collector is measured using low maintenance induction technology and shown on a display for easy viewing. The DPM has programmable thresholds of leakage for switch output indication of dust collector problems such as broken or leaking filters. Proper use of the system will allow the user to catch breaking filters early. Advantages of the system are maintaining regulatory compliance, maximizing product recovery, optimizing filtration efficiency, preventing fines and plant shutdowns, and reducing the amount of pollutants released.

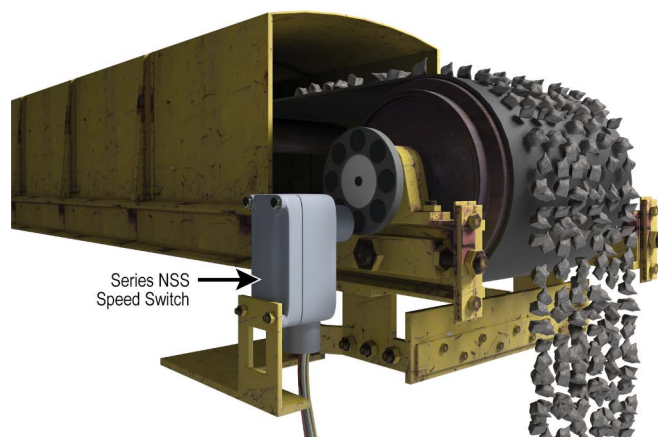

Monitoring belt conveyor for proper operation

A Proximity® Series NSS speed switch is used to monitor the speed of a product belt conveyor indicating proper operation. Common applications include grain, feed, aggregate, mining, and textiles. Belt slippage or a slowdown in belt speed indicates problems that could lead to product waste or could generate sparks leading to a fire or explosion. The belt's speed is monitored via the rotational speed of the shaft at the end of the belt. The NSS is a non-contact magnetic actuated system allowing easy installation and long operational life. A magnetic disc is installed on the rotating shaft and the sensor is mounted across from it. The sensor picks up the rotation of the disc to detect the rotational speed of the belt. Inside the sensor is a programmable switch that can be set for any speed. In this application as the speed decreases and hits the set point the switch is activated for indication of a problem. Proper usage of an NSS can help with predictive maintenance and decrease down-time.

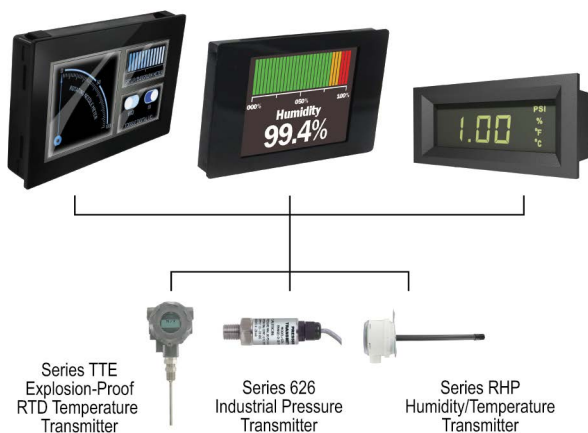

Providing remote indication of pressure, humidity or temperature

The Series DPML, DPMP, and DPMW digital LCD panel meters as well as the SPPM and SPPM2 HMI panel meters provide remote indication in the designated engineering units for pressure, humidity, temperature as well as customizable measurement units. The panel meters can take a voltage or current input signal from transmitters such as the Dwyer® TTE, Series 626 or Series RHP.

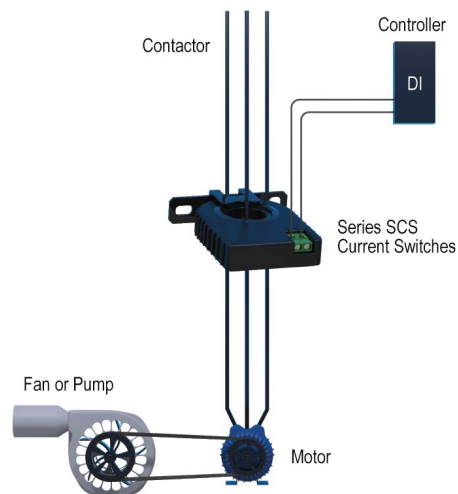

Monitor the status of your fan or pump

The Dwyer® Series SCS current switches monitor the input current into a fan or pump motor starter in order to monitor the status of the equipment. As the current passes through the core of the switches, it generates enough energy to power up the switch eliminating the need for extra power wires. The solid core models are typically used on new installations, while the split core models are able to mount on existing or new installations.

Dwyer

2-WAY Automated Ball Valves

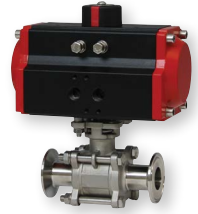
**WE01****WE08****WE02****WE03**

SERIES	WE01	WE08	WE02	WE03
Body Type	2-way 2-piece	2-way 2-piece	2-way 3-piece	2-way 3-piece
Body Material	316 SS	Brass	316 SS	316 SS
Line Sizes	1/2 to 3"	1/2 to 2"	1/2 to 2"	1/2 to 2"
End Connections	Female NPT	Female NPT	Female NPT	Tri-clamp

3-WAY Automated Ball Valves

**WE31****WE35****WE33****WE34**

SERIES	WE31	WE35	WE33	WE34
Body Type	3-way	3-way	3-way	3-way
Body Material	316 SS	Brass	316 SS	316 SS
Line Sizes	1/2 to 2"	1/2 to 2"	1/2 to 2"	1/2 to 3"
End Connections	Female NPT	Female NPT	Tri-clamp	Flange

These Selection Guides are for quick comparison of similar products. Please refer to the catalog page number referenced for complete product information and specifications.

2-WAY Automated Ball Valves



SERIES	WE04	WE05	WE06	WE07
Body Type	2-way 2-piece	2-way 3-piece	2-way 3-piece V-ball	2-way 2-piece V-ball
Body Material	316 SS	316 SS	316 SS	316 SS
Line Sizes	1/2 to 3"	1/2 to 3"	1/2 to 3"	1/2 to 3"
End Connections	Flange	Socket weld	Female NPT	Flange

POSITIONERS



SERIES	165 & 265	185 & 285	195 & 295
Body Material	Aluminum or 316 SS	Aluminum or 316 SS	Aluminum
Stroke	0.5 to 6" or 0 to 90°	0.5 to 6" or 0 to 90°	0.19 to 1.38" or 0 to 90°
Air Supply	20 to 101 psig	35 to 116 psi	35 to 116 psi
Enclosure Rating	IP66	NEMA 4X	NEMA 4X

Dwyer

HAND LEVER

Ball Valves

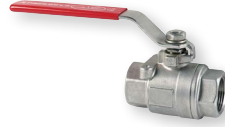
**DBV****BV2M****DBVL****SWBV**

SERIES	DBV	BV2M	DBVL	SWBV
Body Type	2-way	2-way	2-way	2-way
Body Material	Brass	CF8M	Low lead brass	Brass
Line Sizes	1/4 to 3"	1/4 to 3"	1/4 to 3"	1/4 to 3"
End Connections	Female NPT	Female NPT	Female NPT	Sweat

POSITION INDICATORS/SWITCHES/TRANSMITTERS

**QV****Mark 1****Mark 3**

SERIES	QV	Mark 1	Mark 3
Type	Thru-shaft	Magnetic drive	Magnetic drive
Rotation Travel	5 to 360° (switches only)	0 to 340°	1 to 25 revolutions
Enclosure Material	Polycarbonate	Aluminum or 316 SS	Aluminum or 316 SS
Enclosure Rating	NEMA 4, 4X	NEMA 1, 2, 3, 3R, 3S, 4, 4X, 6, 7, 9, 12, & 13	NEMA 1, 2, 3, 3R, 3S, 4, 4X, 6, 7, 9, 12, & 13

These Selection Guides are for quick comparison of similar products. Please refer to the catalog page number referenced for complete product information and specifications.

HAND LEVER Ball Valves



SERIES	UBV	MV	SMV2
Body Type	Uni-flange	2-way	2-way
Body Material	Brass	Chrome-plated brass	SS
Line Sizes	1/2 to 1"	1/8 to 1/2"	1/8 to 1/2"
End Connections	Female NPT	Female x female NPT or Male x female NPT	Female x female NPT or Male x female NPT

POSITION INDICATORS/SWITCHES/TRANSMITTERS



SERIES	Mark 4	VPS	DT
Type	Thru-shaft	Dual Inductive	Magnetic Point Sensor
Rotation Travel	0 to 340°	N/A	N/A
Enclosure Material	Aluminum or 316 SS	Polybutylene Terephthalate	SS
Enclosure Rating	NEMA 1, 2, 3, 3R, 3S, 4, 4X, 6, 7, 9, 12, & 13	N/A	Designed to NEMA 1, 3, 4, 4X, 6, 7, 9, 12 & 13

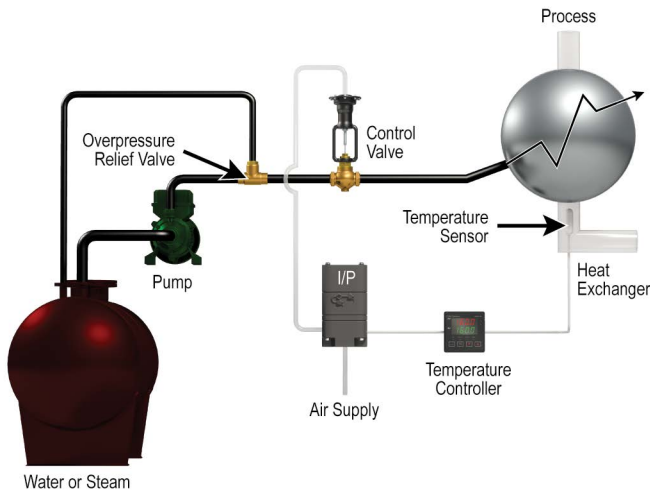

Process temperature control using pneumatic Hi-Flow™ control valves

Pneumatic Hi-Flow™ control valves provide excellent control with high flow, wide rangeability and tight shutoff capabilities. The dispensing application shown uses a Lin-E-Aire® pneumatic actuator, operating off standard 3-15 psi control air signals, and a Hi-Flow™ linear control valve that apportions steam or water to a user process. The valve regulates cooling water or steam flow depending on the process requirement resident in the temperature controller program. This package can be provided with a Precisor® positioner and Proximity position transmitter which provides an excellent process control application problem solution.

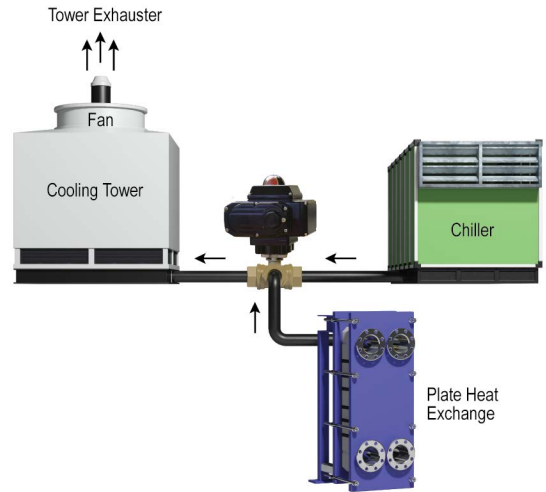

Water-side economizer system includes Series WE31 3-way ball valve for accurate control of flow

To ensure efficient utilization of cold water in HVAC systems, WE31 3-way ball valves are called upon to modulate flow. This common “water-side economizer” allows water from the plate heat exchanger to be diverted directly to the cooling tower if the temperature is cool enough, instead of coming directly from the condenser on the chiller.

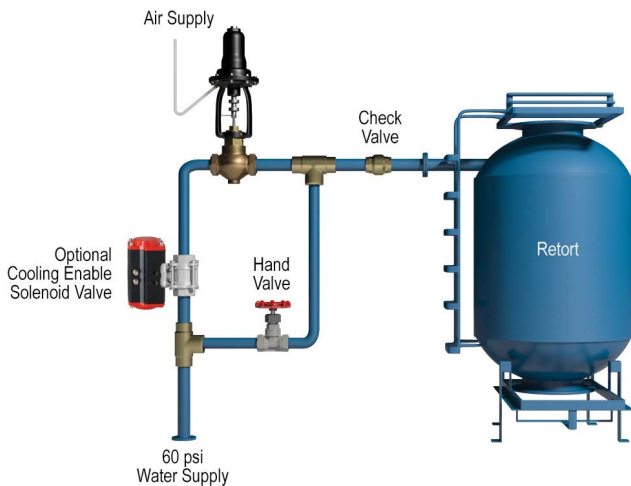

Quick response Hi-Flow™ valves control water flow in cooling process

Dependable W.E. Anderson™ Hi-Flow™ control valves with Lin-E-Aire® air-to-raise actuators combine to provide unsurpassed water flow management. This retort system employs the Hi-Flow™ valve because of its excellent control capabilities, which are necessary for this application. After the cooking process, the valve is opened slowly. Once the desired temperature has been reached, the supply is shut off and any additional cooling is done by use of the hand valve.

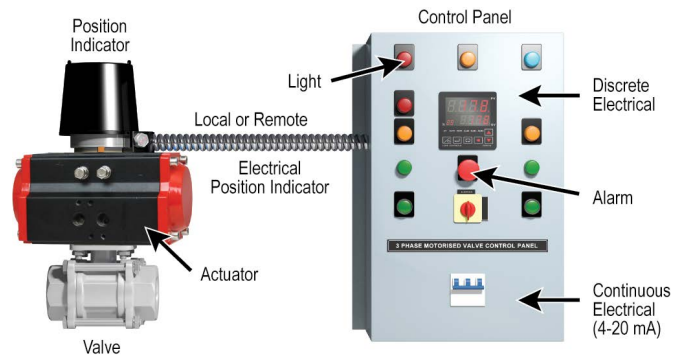

Proximity® Mark Series valve position indicator is perfect for valve position indication on offshore oil rigs

Proximity® Mark Series position indicator is utilized in valve automation packages in harsh environments. The Mark Series mounts onto the top of rotary valve actuators and connects to the actuator shaft or attaches to the shaft of a linear valve for indicating valve position. Standard with the Mark Series is visual position indication with “OPEN”, “CLOSED”, and degree position status. The Mark Series is available with continuous position retransmission with a 4-20 mA output and up to six adjustable position indication switches for remote indication of valve status. Remote status transmitter is used for indication of exact valve position and switches provide discrete indication of valve open and closed status in the control room. The Mark Series is perfect for this application because of the 316 SS enclosure that withstands the sea spray environment, and the magnetic drive mechanism that completely seals the switch cavity from the environment.

**REGISTERED TRADEMARKS
OF DWYER INSTRUMENTS, INC.**

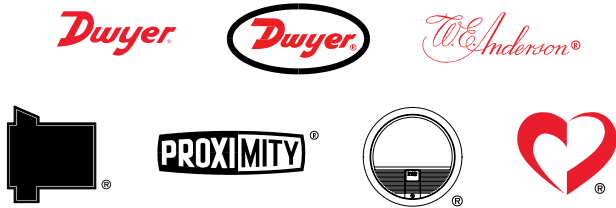

Capsuhelic®	Lin-E-Aire®	Photohelic®
Capsu-Photohelic®	Love®	Plast-A-Vane®
DigiHelic®	Magnehelic®	Precisor® Quick-View®
DigiMag®	MagneSense® Mercoid®	Rate-Master®
Duotect®	Mercoid Control®	Safe-T-Ohm®
Durablock®	Minihelic® Mini-Master®	Slack Tube®
Dwyer®	Mini-Photohelic®	SMART Air Hood®
Flex-Tube®	Mobile Meter®	Spirahelic®
Flotect®	One-Touch®	Visi-Float®
Iso Verter®	Optitrol®	

**COMMON LAW MARKS
OF DWYER INSTRUMENTS, INC.**



AQStick™	Minitactor™	Tell Tale™
Even-Action™	ModuSENSE™	Tell Tale Jr.™
FlexiSENSE™	Mother Node™	Ultra-Mag™
Hi-Flow™	PredictAir™	Ultra-View™
Lovelink™	Proximity™	Vaneometer™
Mini-Node™	StabiliSENSE™	

COMMONLY USED MARKS & GRAPHICS



MARKS REGISTERED TO COMPANIES OTHER THAN DWYER INSTRUMENTS, INC.



Alumel®	Conceptech, Inc.	IOS®	Cisco Systems, Inc.	Velcro®	Velcro Industries B.V.
Android®	Google, Inc.	Lexan®	SABIC Innovative Plastic IP B.V.	Windows®	Microsoft Corporation
Chromel®	Conceptech, Inc.	Loctite®	Henkel Corporation	Windows NT®	Microsoft Corporation
Darina®	Shell Trademark Management B.V.	Modbus®	Schneider Automation, Inc.	Windows Vista®	Microsoft Corporation
Duracell®	The Gillette Company	Norpren®	Saint-Gobain Abrasives, Inc. Corporation	Excel®	Microsoft Corporation
Eveready®	Eveready Battery Company, Inc.	Nylatch®	Southco, Inc.	PowerPoint®	Microsoft Corporation
Fluon®	AGC Chemicals Americas, Inc.	Open I/O®	Easton Controls, Inc.	Air Flow™	TSI, Inc.
Fluorolube®	Gabriel Performance Products LLC	Open Signal®	Easton Controls, Inc.	No More	Permatex
Freon®	E.I. DuPont De Nemours and Company	Sensorpak®	Easton Controls, Inc.	Leaks™	Sierra Instruments, Inc.
HART®	Hart Communication Foundation	Sensorpulse®	Easton Controls, Inc.	Precision Flow™	TSI, Inc.
Hirschmann®	Hirschmann Electronics GMBH	Swagelock®	Swagelock Company	ProHood™	lentek Co., Ltd.
HyperTerminal®	Hilgraeve, Inc.	Trendreader®	ACR Systems, Inc.	Smart	
Igslide®	Igus GMBH	Tygon®	Saint-Gobain Abrasives, Inc. Corporation	Interface™	
Inconel®	Huntington Alloys Corporation	VCR®	Swagelok Company		

INFORMATION ABOUT MERCURY-ADDED PRODUCTS

Dwyer Instruments, Inc. continues its development of non-mercury replacement alternatives for those products currently offered containing mercury. We will continue to work with all customers to supply mercury added products as needed for replacement of products currently in use and to guide customers towards non-mercury added products for new applications.

Dwyer Instruments, Inc. will comply with all local, state, federal, and international laws regarding the sale of mercury added products. These laws may affect our ability to sell, distribute, or transport products into restricted states and/or countries. Mercury added product sales may be limited or denied to certain customers depending on the location or intended use of the product.

Dwyer Instruments, Inc. encourages all customers to become familiar and comply with all mercury legislation. Sales of any and all mercury added products will be discontinued to any customer that knowingly or willfully disregards any legislation concerning mercury.

Dwyer Instruments, Inc. requests that all mercury containing products are properly disposed of at the end of their useful life. Many web sites are available to help educate consumers about proper disposal of mercury added products. Please visit www.newmoa.org for additional information related to mercury usage.



HVAC

PRODUCT APPLICATIONS & SELECTION GUIDES

Pressure | Temperature | Test & Data | Air Quality

Flow | Level | Process Control | Valves



dwyer-inst.com